

STREAMLINE ALL WING STRUTS

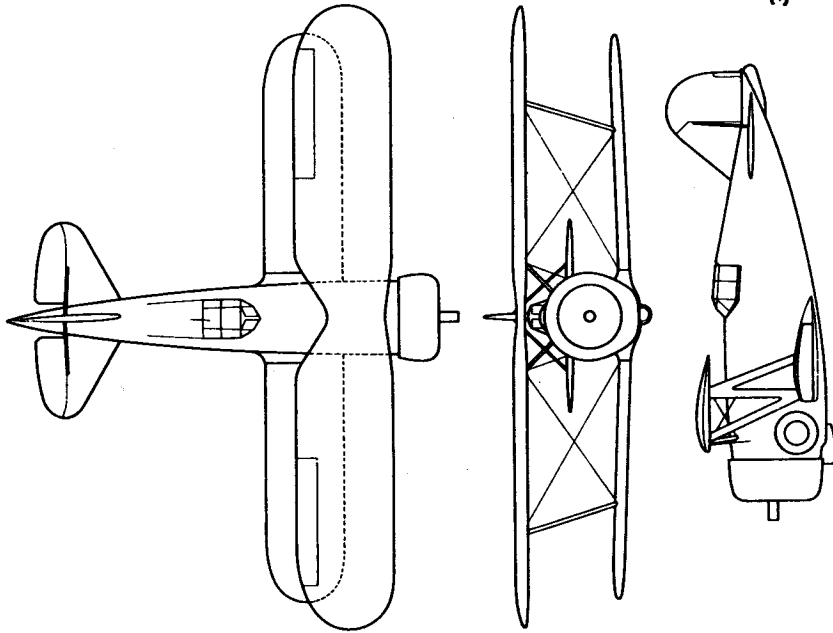

**GRUMMAN F3F-2**

A single-place, U. S. Navy fighter, adaptable to operation from aircraft carriers. Many of these planes have seen service with the Marines. Retractable wheels fold to sides of fuselage. Span 32', Length 23' 3".

*Identification*

Biplane with parallel, staggered wings, the lower one having shorter span and chord. Upper wing has a deep "bite" in trailing edge at center, and slight indentation directly forward in entering edge. Interplane "N" struts. Stubby fuselage with small "greenhouse" aft of wings. Large tail surfaces.

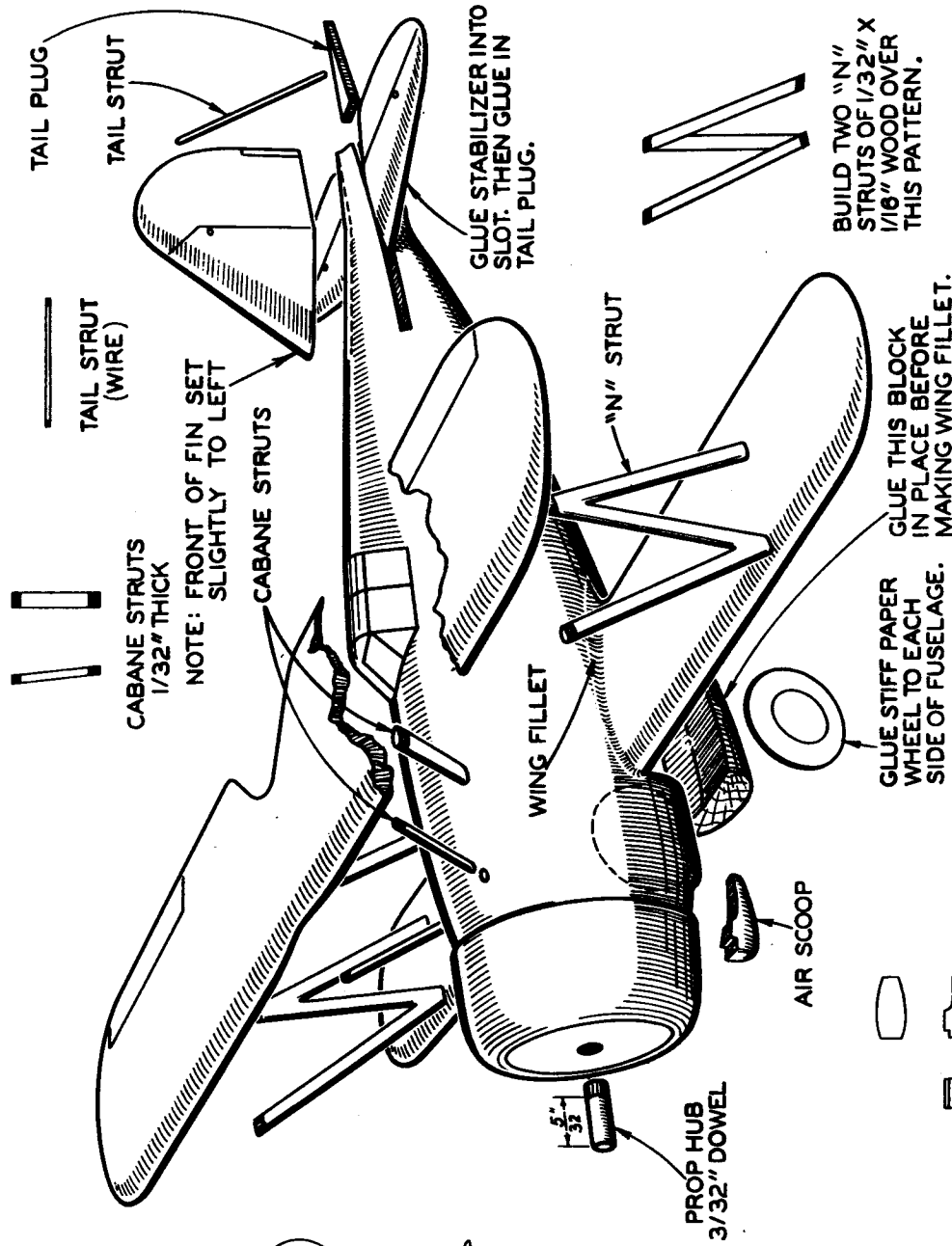

GLUE STIFF PAPER WHEEL TO EACH SIDE OF FUSELAGE. GLUE THIS BLOCK IN PLACE BEFORE MAKING WING FILLET.

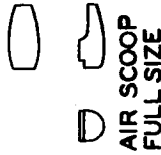

This plan is identical to the one used in the Model Building Program of the U. S. Office of Education sponsored by the U. S. Navy, Bureau of Aeronautics.

MODEL

MODEL

**GRUMMAN F3F-2**  
U.S. NAVY FIGHTER  
FINAL ASSEMBLY

SPAN 5-11/32" SERIAL NO. C-1 DATE 4-15-42

COMET MODEL AIRPLANE & SUPPLY CO., INC.

Fuselage	1x1 1/4x4
Top Wing	1/2x1x5 1/2
Bottom Wing	3/4x3/4x5
Tail	1x1x2 1/2
Struts	1/32" thick
Prop. Hub	3/32" dowel

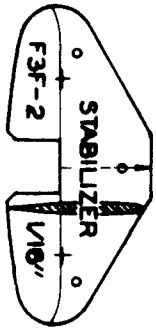
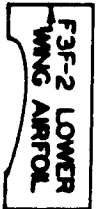
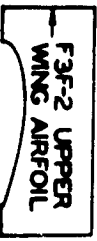
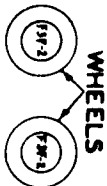
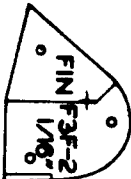
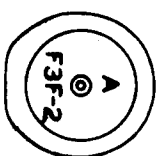
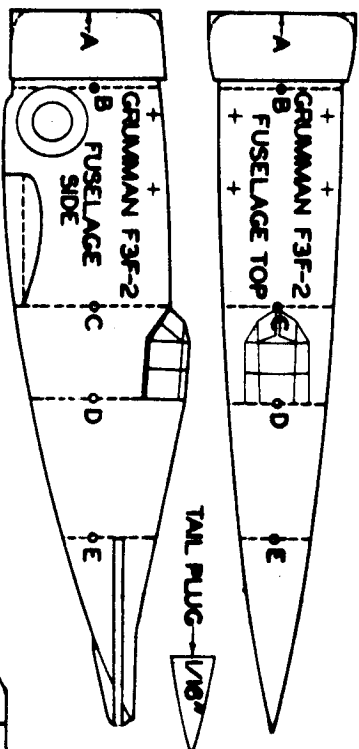
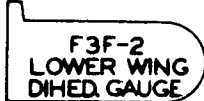
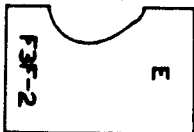
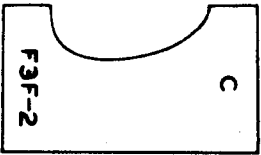
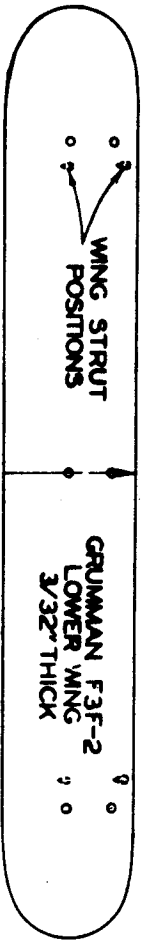
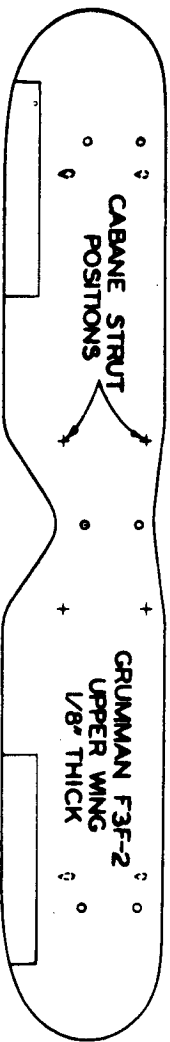

MODEL	 <b>GRUMMAN F3F-2</b> U.S. NAVY FIGHTER TEMPLATES			MODEL
SCALE 1:72				SERIAL NO. C-1
COMET MODEL AIRPLANE & SUPPLY CO., INC.				