

CURTISS P-40E

A single place U. S. Army fighter powered by a liquid-cooled, in-line Allison engine. This is an improved version of the P-40D, called "Kittyhawk" by the R.A.F. Span 37' 4", Length 31' 9".

Identification

Low-wing monoplane. Very slight sweepback on leading edge of wing, trailing edge swept forward to rounded tips. Small "knees" for housing retracted landing gear struts under wings near fuselage. Long nose with row of exhausts on each side and large radiator below.



DIMENSIONS FOR TAPERING WING BLOCK

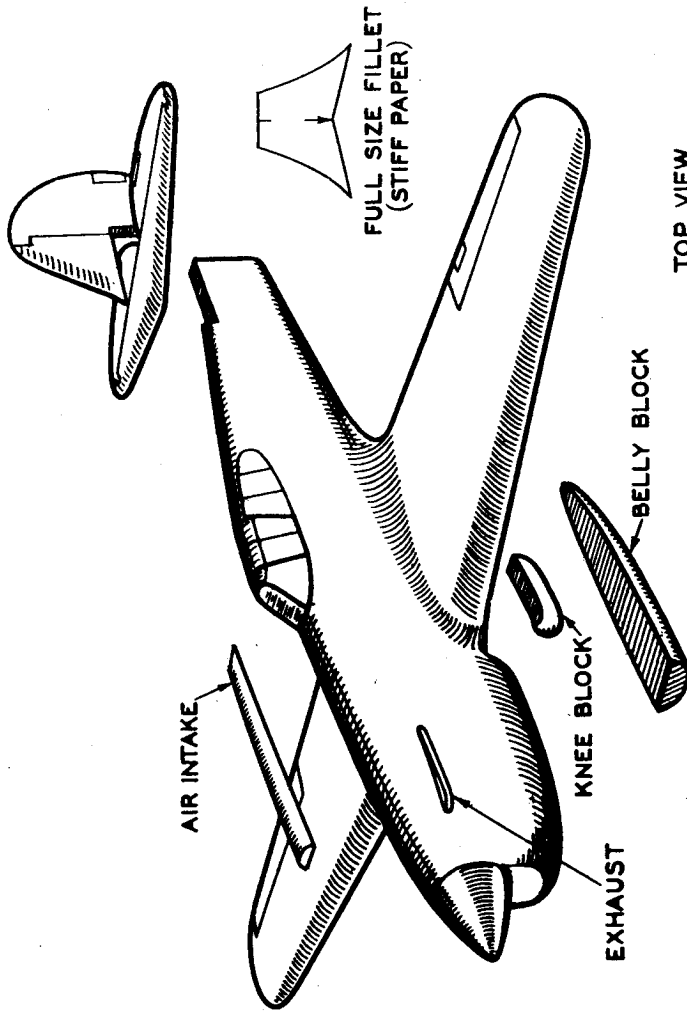

TOP VIEW
EXHAUST - FULL SIZE

BELLY BLOCK CONSTRUCTION

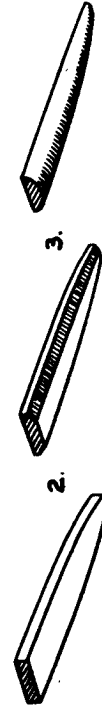

BILL OF MATERIALS

Fuselage	$\frac{1}{4} \times 1 \frac{1}{2} \times 5 \frac{1}{4}$
Wing	$\frac{3}{16} \times 1 \frac{1}{2} \times 6 \frac{1}{2}$
Tail	$\frac{1}{8} \times 1 \frac{1}{2} \times 3 \frac{1}{2}$
Belly Block	$\frac{1}{4} \times \frac{1}{2} \times 1 \frac{1}{4}$
Knee Blocks	$\frac{1}{8}$ thick

MODEL

MODEL



CURTISS P-40E
U.S. ARMY FIGHTER
FINAL ASSEMBLY

SPAN 6-7/32" SERIAL NO. A-9 DATE 2-16-42

U.S. NAVY BUREAU OF AERONAUTICS WASH., D.C.

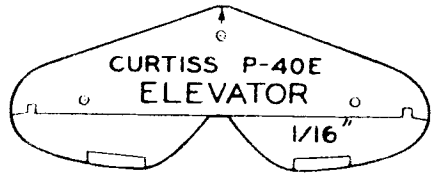
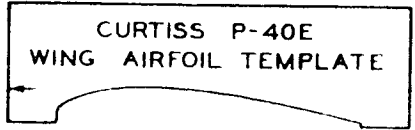
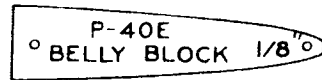
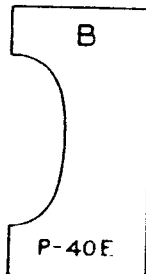
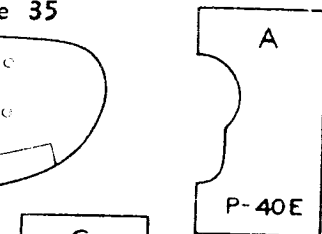
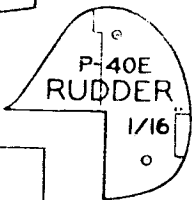
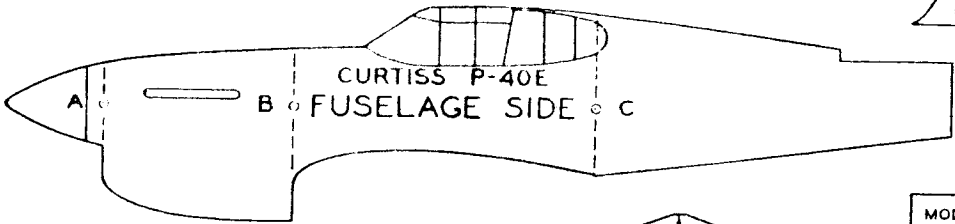
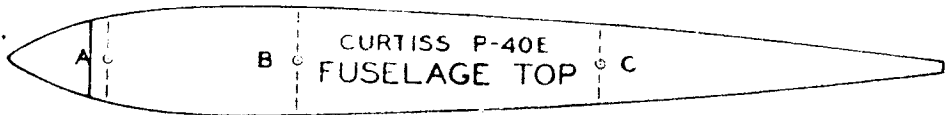
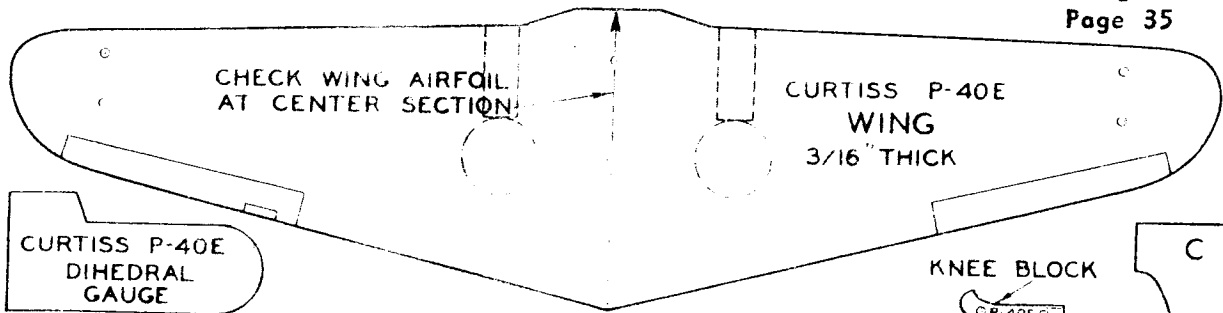

MODEL	 CURTISS P-40E U.S. ARMY FIGHTER TEMPLATES	MODEL
SCALE 1:72	SERIAL NO. A-9	DATE 2-16-42
U.S. NAVY BUREAU OF AERONAUTICS WASH., D.C.		