

The Role of Predictions in Joint Action

Patrick M. Pilarski

*Canada Research Chair in Machine Intelligence for Rehabilitation
Division of Physical Medicine and Rehabilitation, Dept. of Medicine*

Fellow, Alberta Machine Intelligence Institute (Amii)

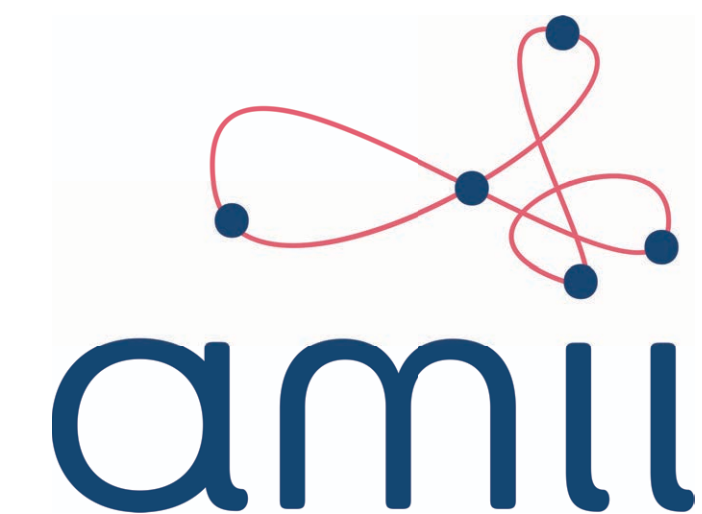

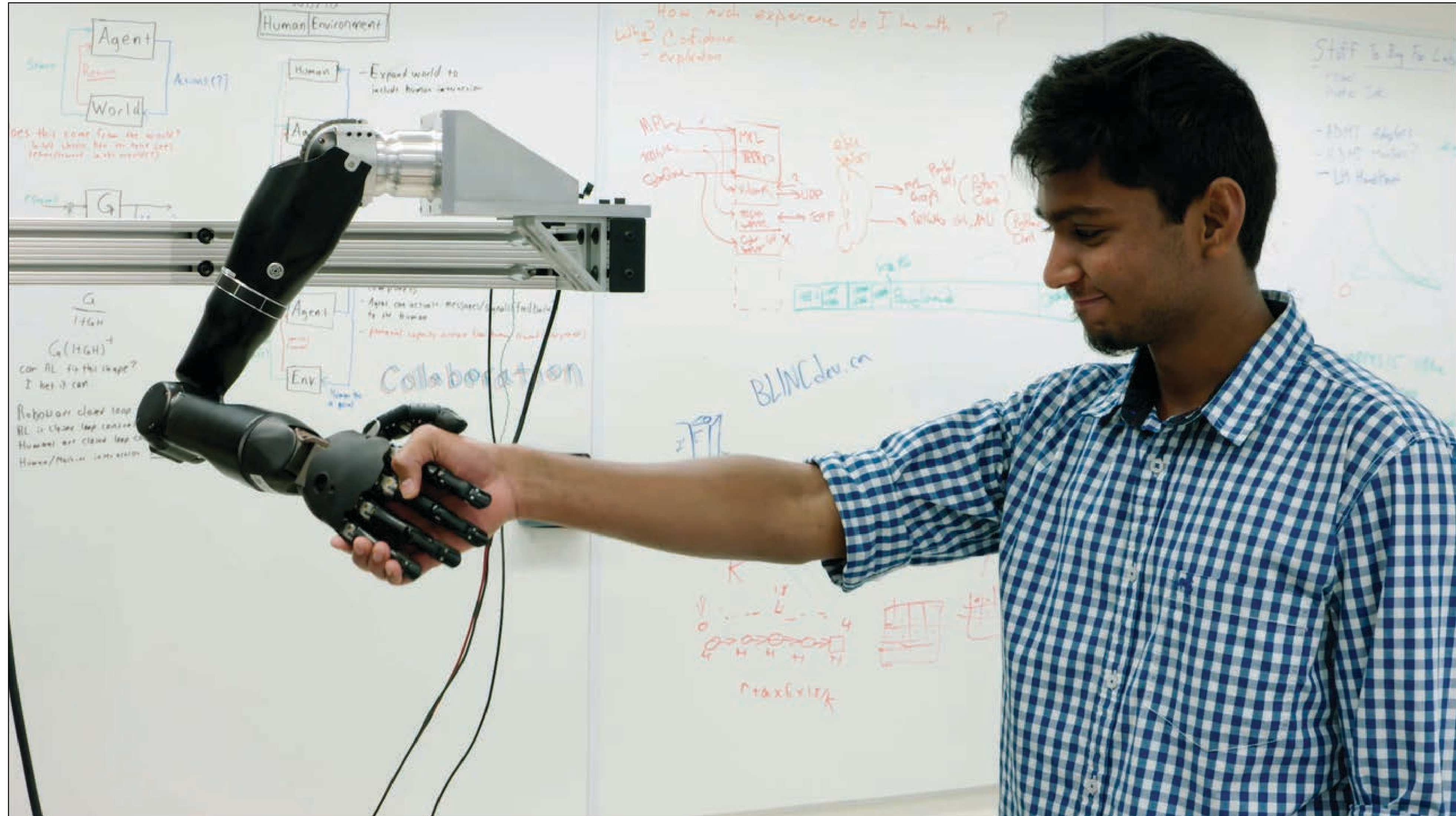

Joint Action?

Joint Action

Pesquita, Whitwell, and Enns,
Psychon Bull Rev 25, 2018: “Predictive joint-
action model: A hierarchical predictive
approach to human cooperation”



JOINT ACTION

“a social interaction whereby two or more individuals coordinate their actions in space and time to bring about change in the environment”

Representation of shared **goal** and individual contributions to the shared goal.

Pesquita, Whitwell, and Enns, *Psychon Bull Rev* 25, 2018: “Predictive joint-action model: A hierarchical predictive approach to human cooperation”
Vesper et al., *Neural Networks* 23, 2010: “A minimal architecture for joint action”

Representation of shared **goal** and individual contributions to the shared goal.

Monitoring and prediction of partner actions.

Pesquita, Whitwell, and Enns, *Psychon Bull Rev* 25, 2018: “Predictive joint-action model: A hierarchical predictive approach to human cooperation”

Vesper et al., *Neural Networks* 23, 2010: “A minimal architecture for joint action”

Representation of shared **goal** and individual contributions to the shared goal.

Monitoring and prediction of partner actions.

Continuous coordination via **continuous improvement of predictions** about a partner's actions.

Pesquita, Whitwell, and Enns, *Psychon Bull Rev* 25, 2018: "Predictive joint-action model: A hierarchical predictive approach to human cooperation"

Vesper et al., *Neural Networks* 23, 2010: "A minimal architecture for joint action"

PREDICTIONS

Momentary.
(e.g., classification decision)

S. Micera, J. Carpaneto, and S. Raspopovic,
“Control of hand prostheses using peripheral
information,” *IEEE Rev. Biomed. Eng.*, 2010.

PREDICTIONS

Momentary.
(e.g., classification decision)

Temporally extended.
(e.g., expected return)

S. Micera, J. Carpaneto, and S. Raspopovic,
“Control of hand prostheses using peripheral
information,” *IEEE Rev. Biomed. Eng.*, 2010.

Sutton et al., “Horde: A Scalable Real-time Architecture for
Learning Knowledge from Unsupervised Sensorimotor
Interaction,” *Proc. of 10th International Conference on
Autonomous Agents and Multiagent Systems (AAMAS)*, 2011.

PREDICTIONS

Momentary.
(e.g., classification decision)

Temporally extended.
(e.g., expected return)

Can be acquired or updated in batches or in real time.

S. Micera, J. Carpaneto, and S. Raspopovic,
“Control of hand prostheses using peripheral
information,” *IEEE Rev. Biomed. Eng.*, 2010.

Sutton et al., “Horde: A Scalable Real-time Architecture for
Learning Knowledge from Unsupervised Sensorimotor
Interaction,” *Proc. of 10th International Conference on
Autonomous Agents and Multiagent Systems (AAMAS)*, 2011.

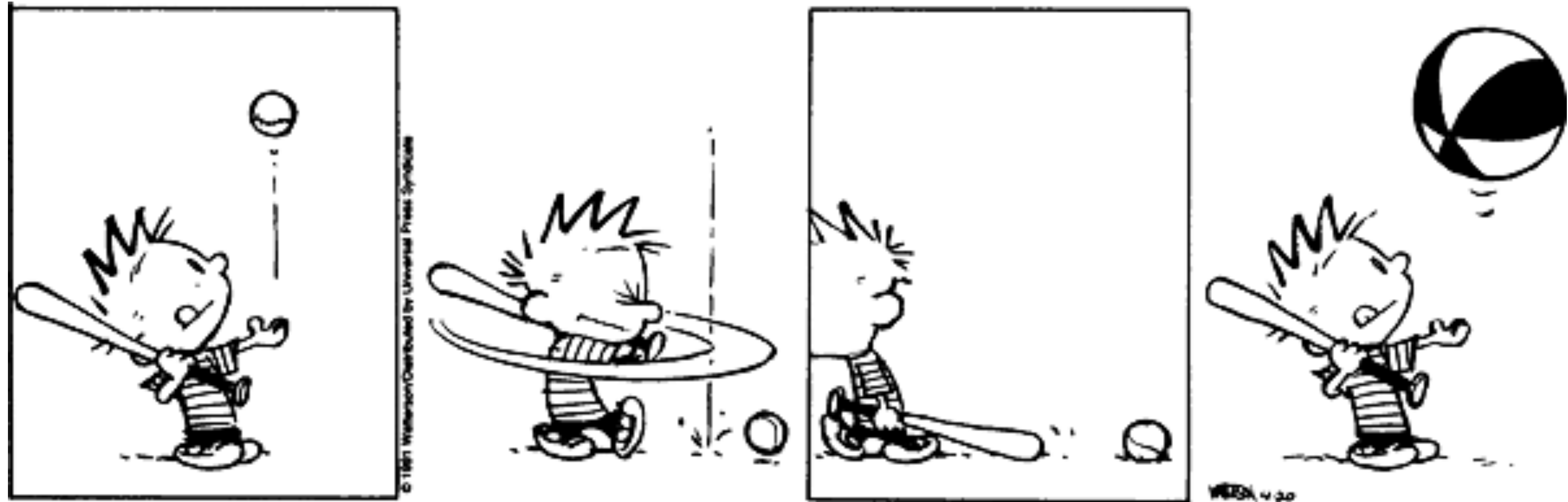

Wolpert et al., *Trends Cog Sci* 5(11), 2001: “Perspectives and problems in motor learning”

Flanagan et al., *Current Biology* 13(2), 2003: “Prediction precedes control in motor learning”

Desmurget et al., *Science* 324(5928), 2009: “Movement intention after parietal cortex stimulation in humans”

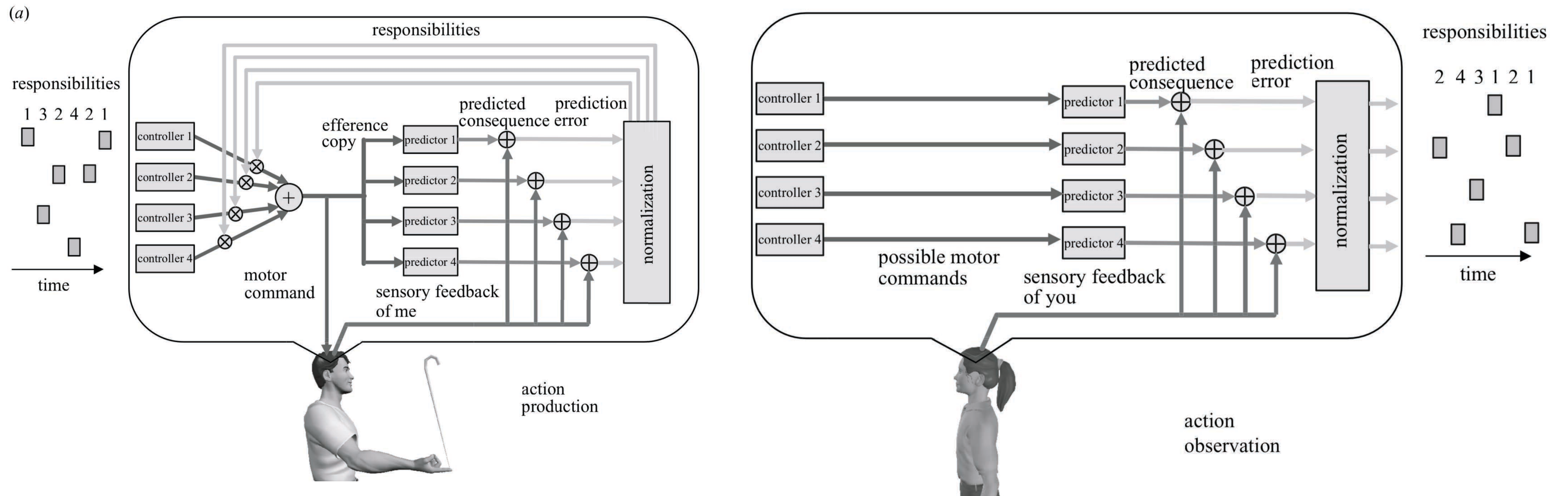

MOSAIC

Wolpert, Doya, and Kawato, *Phil Trans Royal Soc London B*, 358(1431), 2003: “[Motor control and social interaction]”

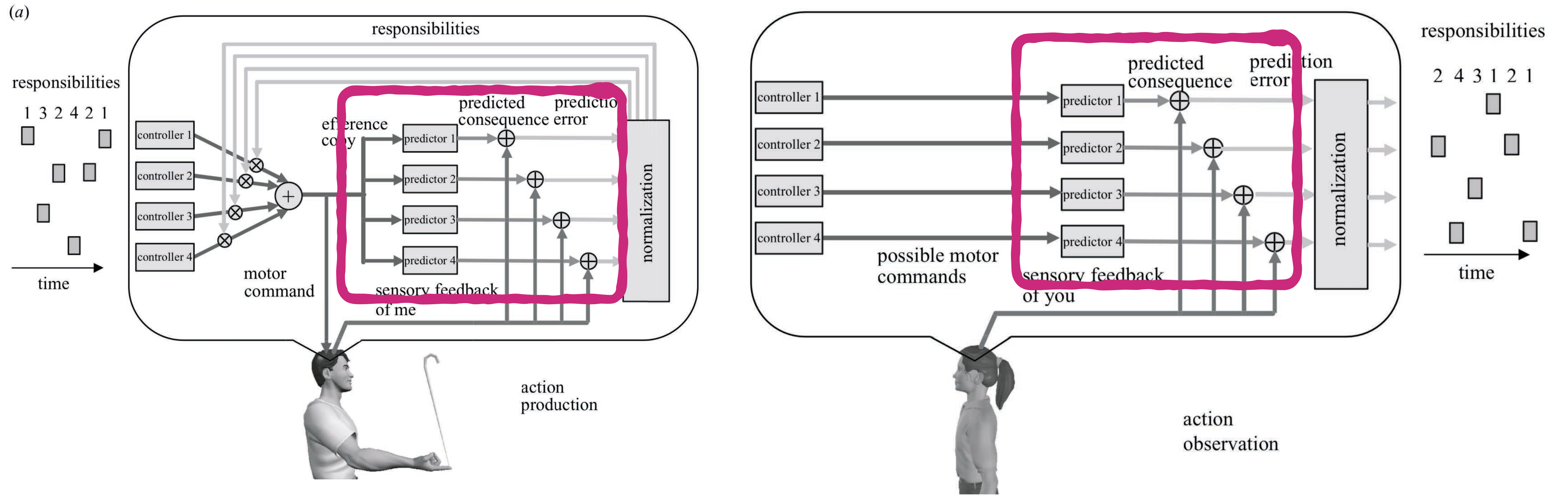

MOSAIC

Wolpert, Doya, and Kawato, *Phil Trans Royal Soc London B*, 358(1431), 2003: “[Motor control and social interaction]”

Predictive Joint-Action Model (PJAM)

Pesquita, Whitwell, and Enns,
Psychon Bull Rev 25, 2018: "Predictive joint-action model:
A hierarchical predictive approach to human cooperation"

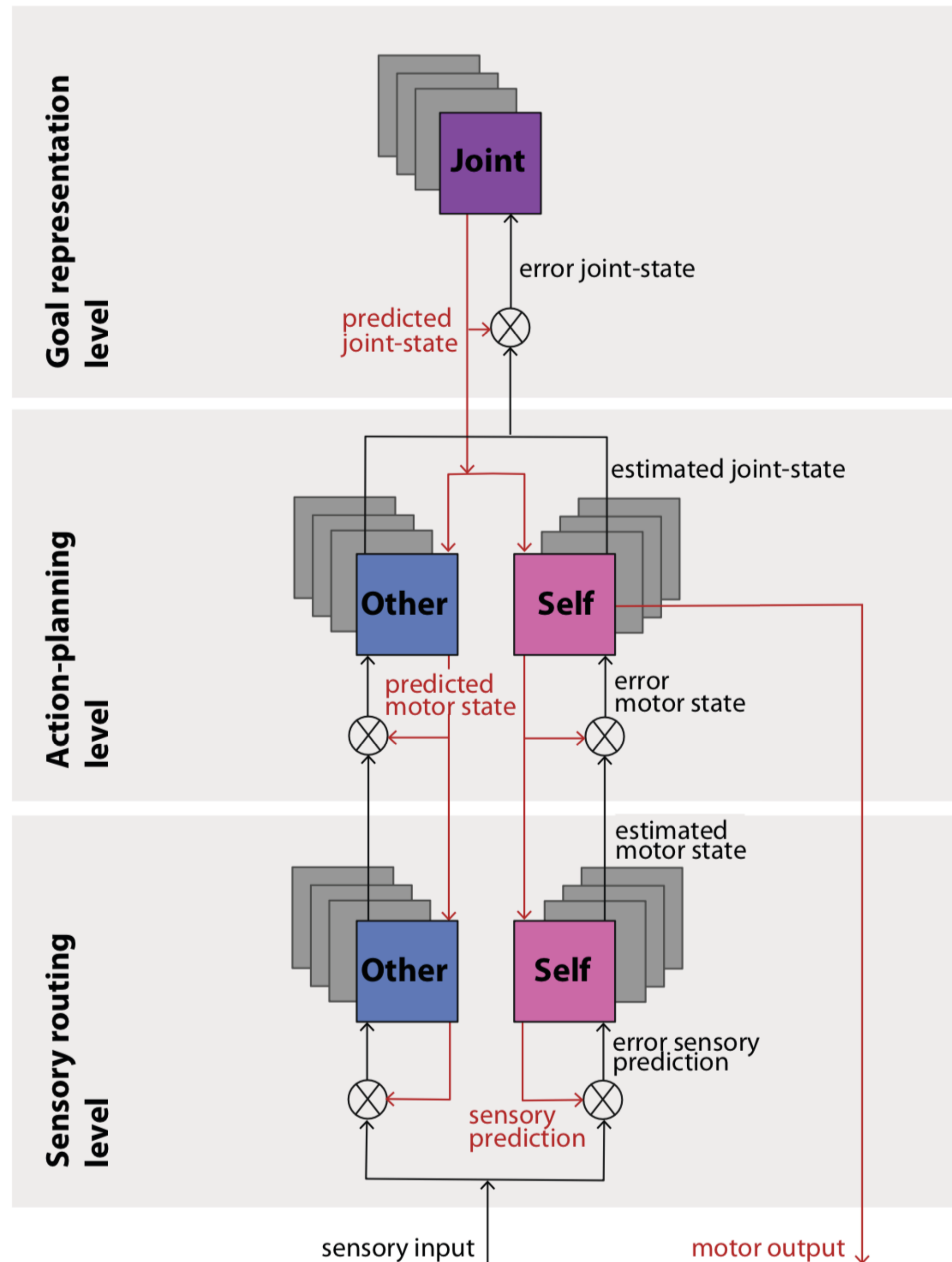

Predictive Joint-Action Model (PJAM)

Pesquita, Whitwell, and Enns,
Psychon Bull Rev 25, 2018: "Predictive joint-action model:
A hierarchical predictive approach to human cooperation"

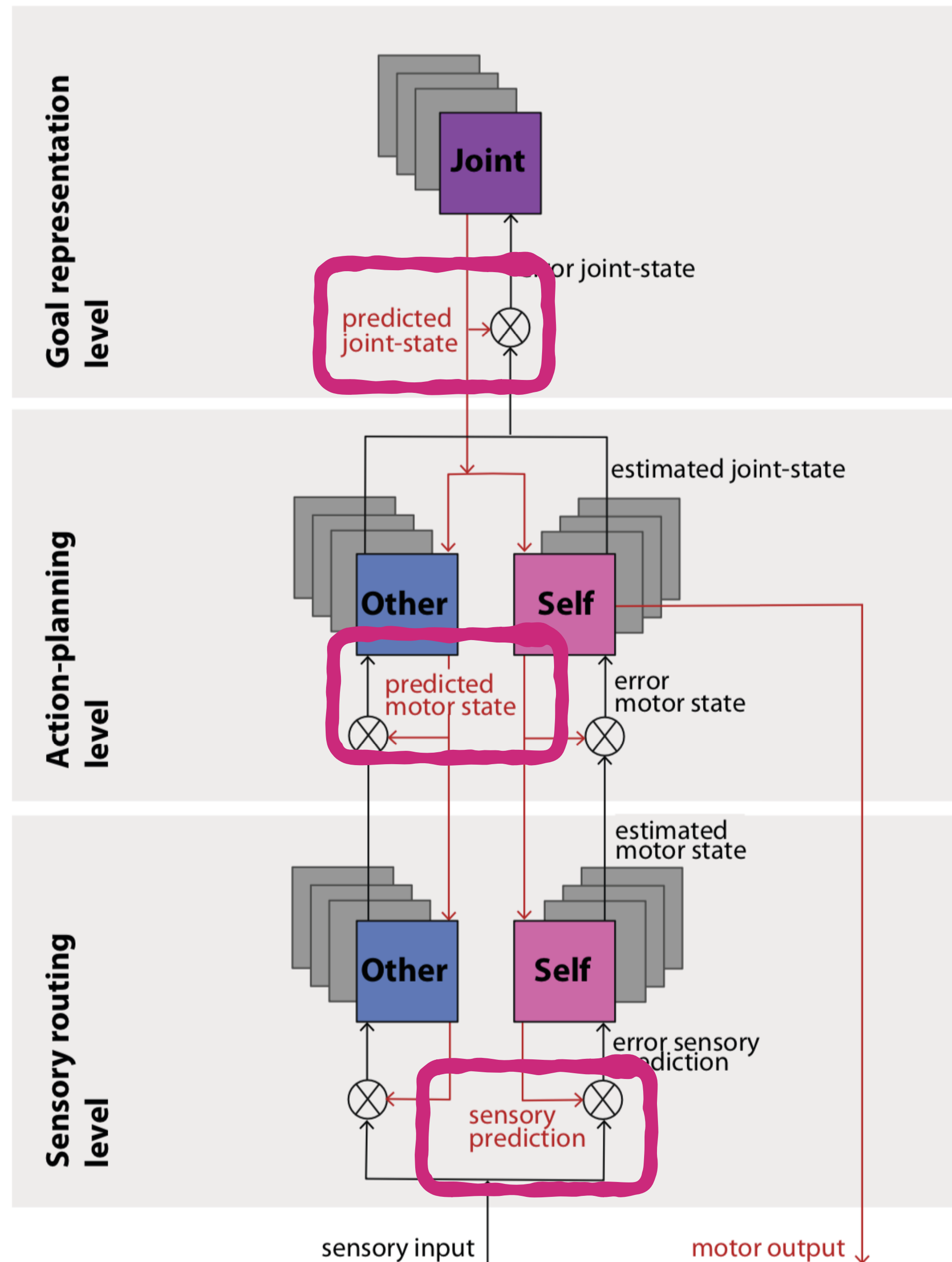

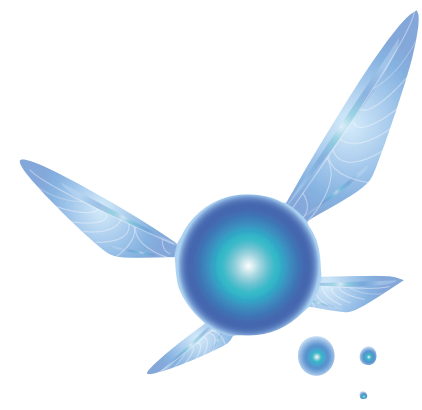

“Hey! Look! (It’s not just for human-human dyads)”

The Legend of Zelda: Ocarina of Time (1998)

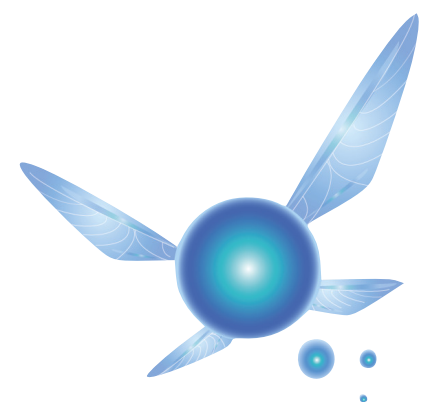

“Hey! Look! (It’s not just for human-human dyads)”

The Legend of Zelda: Ocarina of Time (1998)

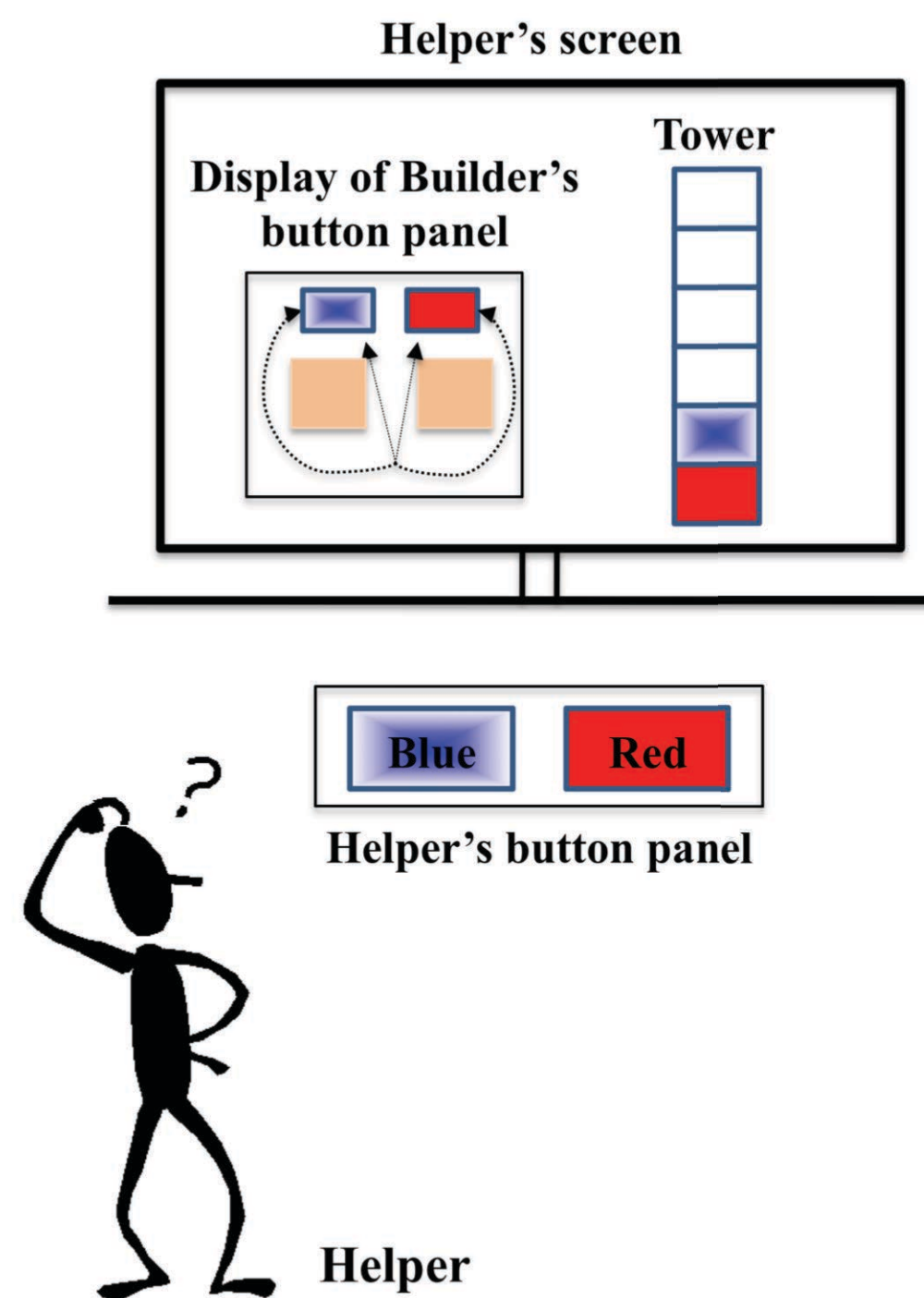

Pezzulo, G., Dindo, H. (2011). What should I do next? Using shared representations to solve interaction problems. *Exp. Brain. Res.* 211, 613–630.

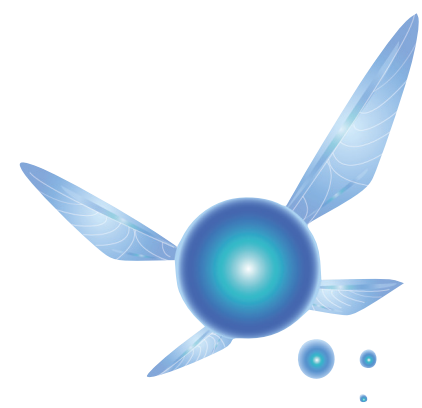

“Hey! Look! (It’s not just for human-human dyads)”

The Legend of Zelda: Ocarina of Time (1998)

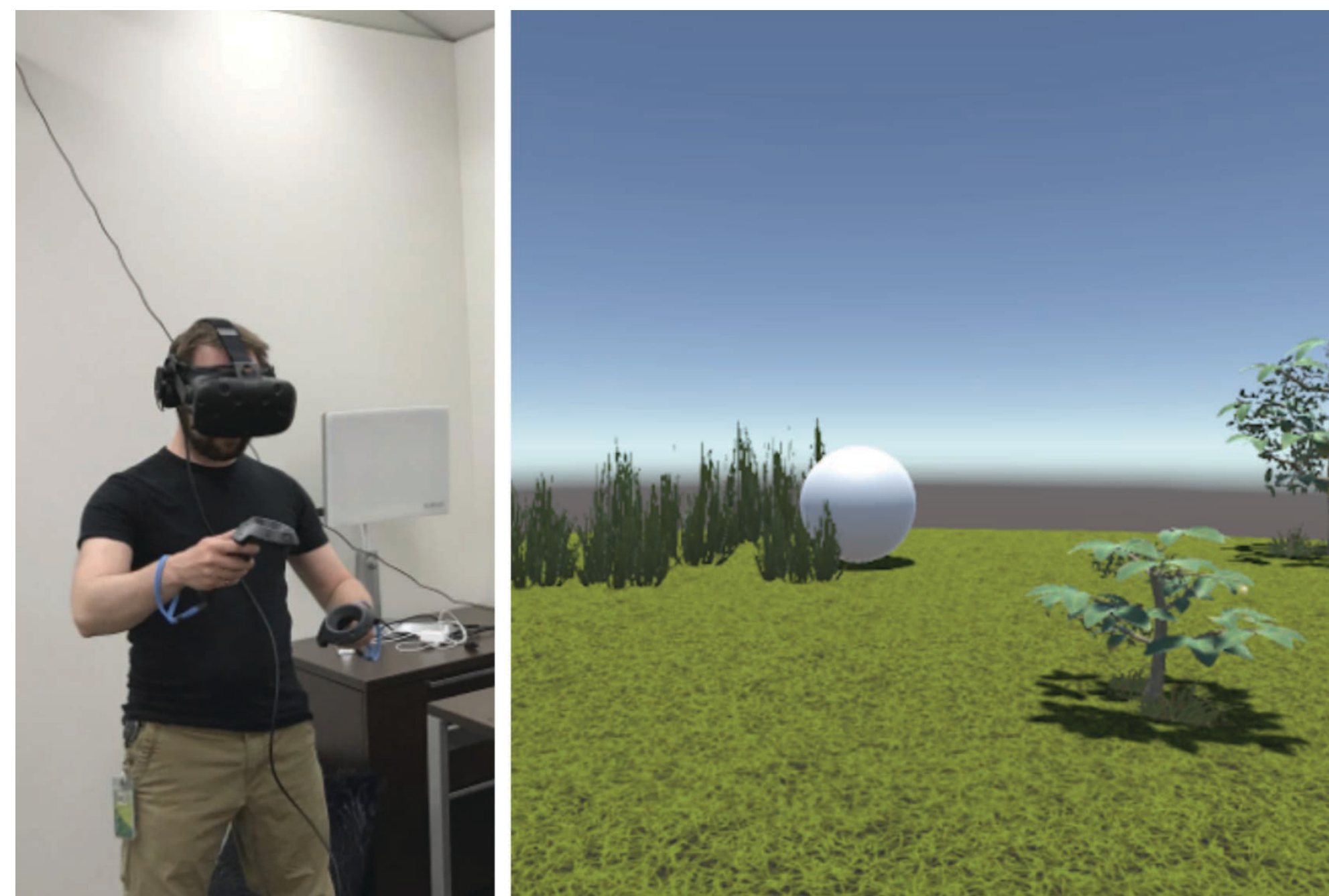
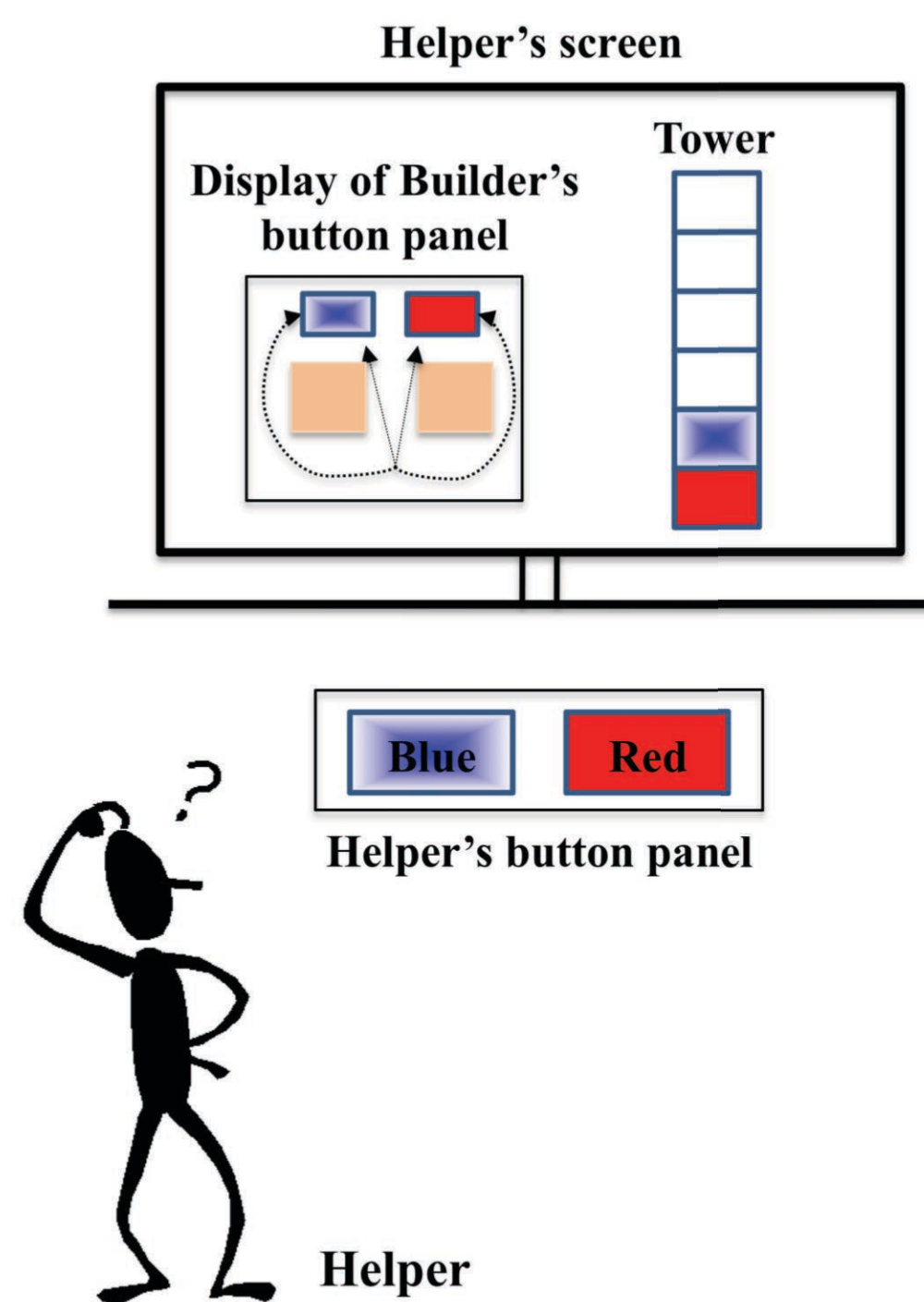

Pezzulo, G., Dindo, H. (2011). What should I do next? Using shared representations to solve interaction problems. *Exp. Brain. Res.* 211, 613–630.

P. M. Pilarski, A. Butcher, M. Johanson, M. M. Botvinick, A. Bolt, A. S. R. Parker, “Learned human-agent decision-making, communication and joint action in a virtual reality environment,” *RLDM 2019 / arXiv:1905.02691 [cs.AI]*, 5 pages, 2019.

Predictions as *Communicative Capital*

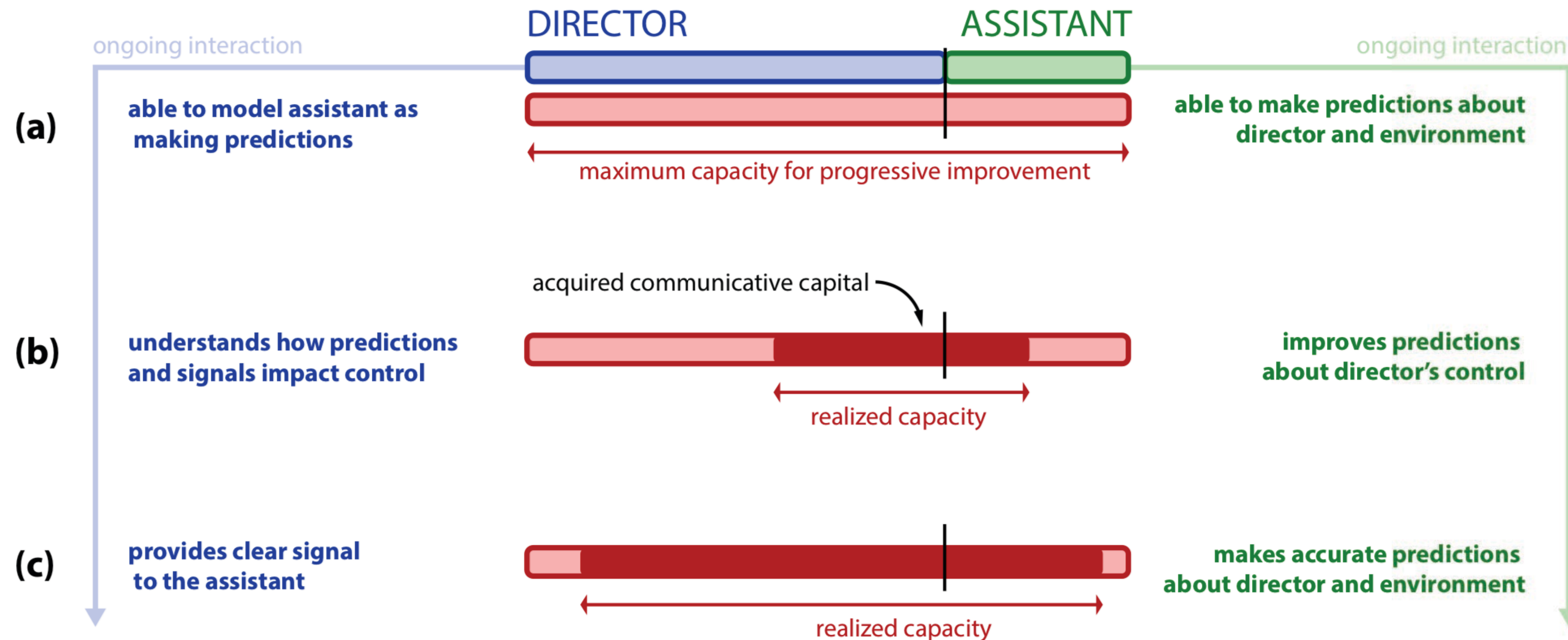

P. M. Pilarski, R. S. Sutton, K. W. Mathewson, C. Sherstan, A. S. R. Parker, A. L. Edwards, "Communicative Capital for Prosthetic Agents," arXiv:1711.03676 [cs.AI] (arXiv): 33 pages, 2017.

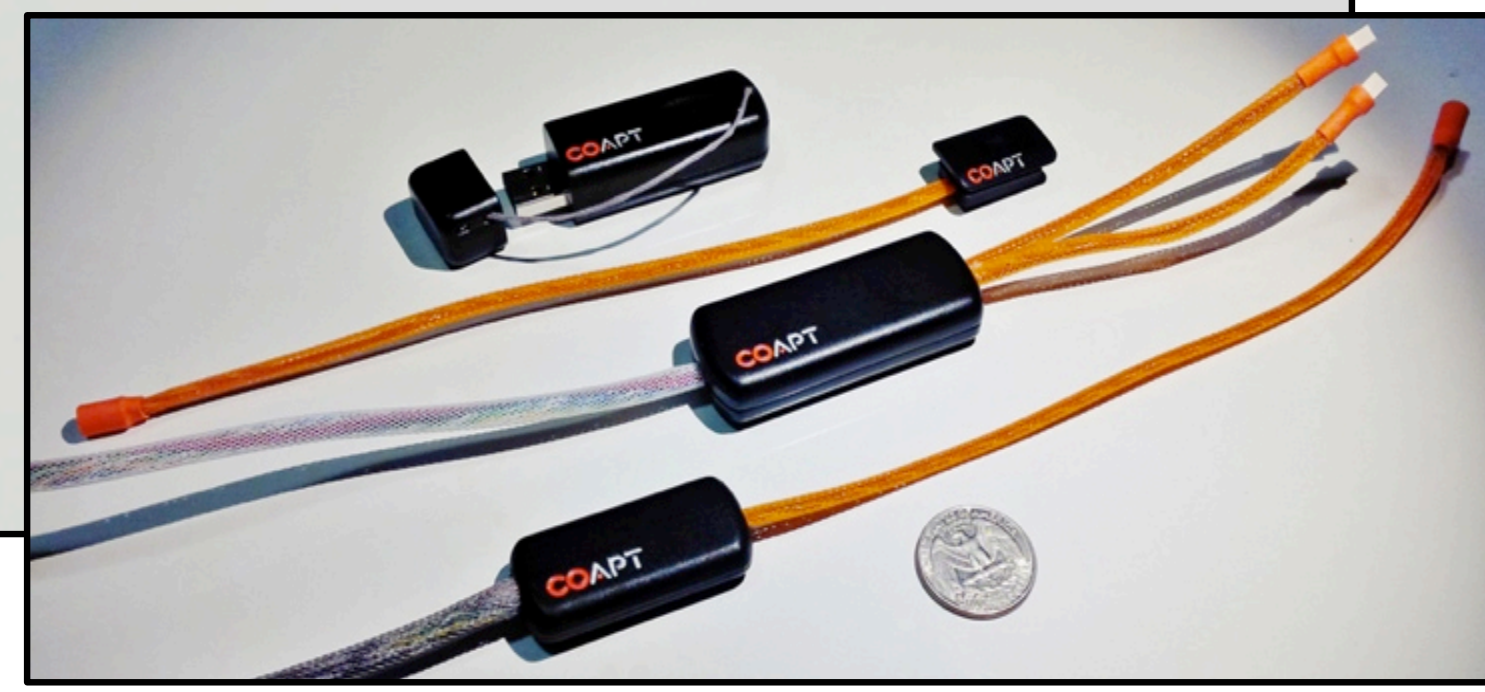

Commercially Deployed
Pattern Recognition for Prostheses

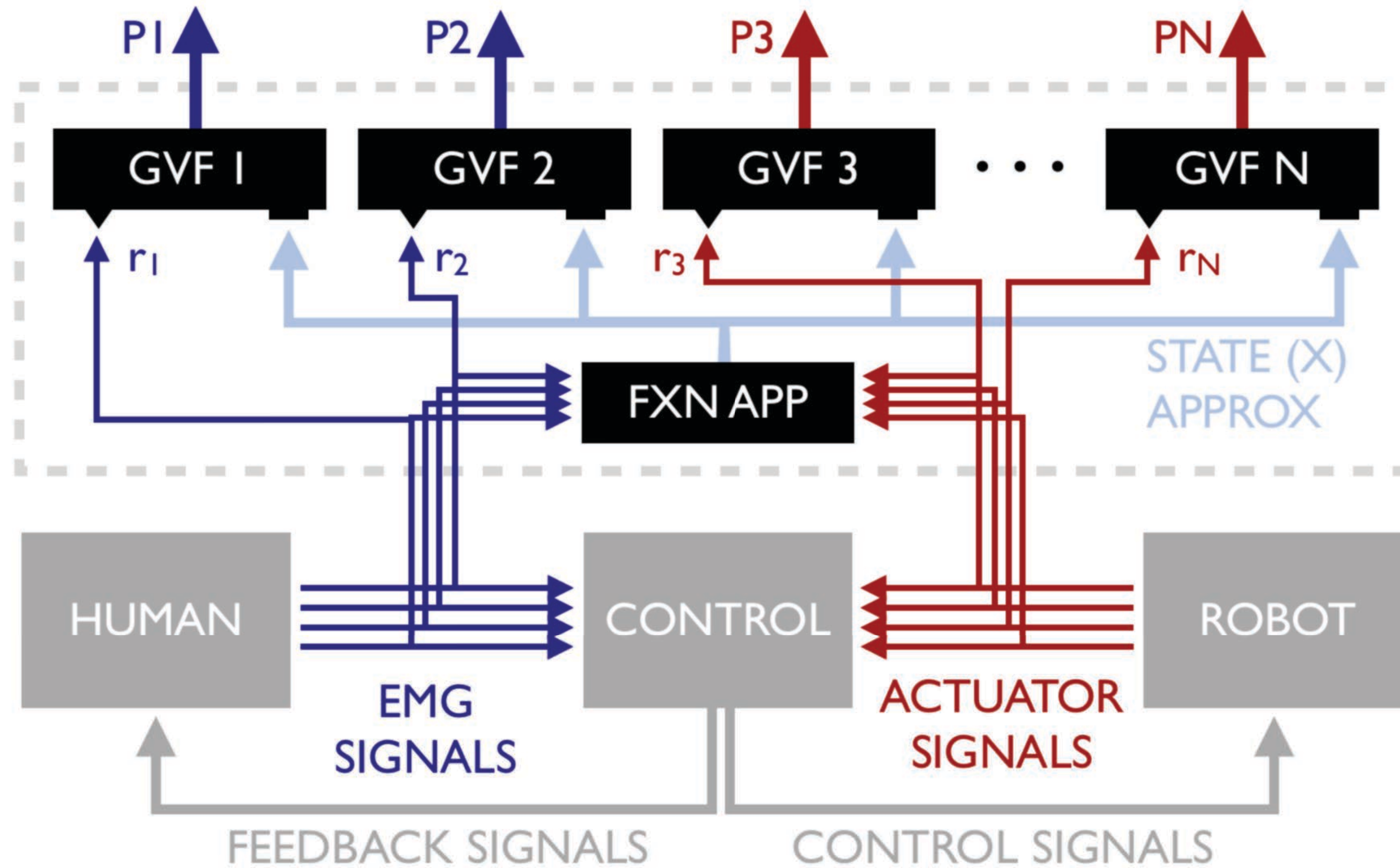

P.M. Pilarski, M.R. Dawson, T. Degris, J.P. Carey, K.M. Chan, J.S. Hebert, and R.S. Sutton, "Adaptive Artificial Limbs: A Real-time Approach to Prediction and Anticipation," *IEEE Robotics & Automation Magazine*, Vol. 20(1): 53–64, March 2013.

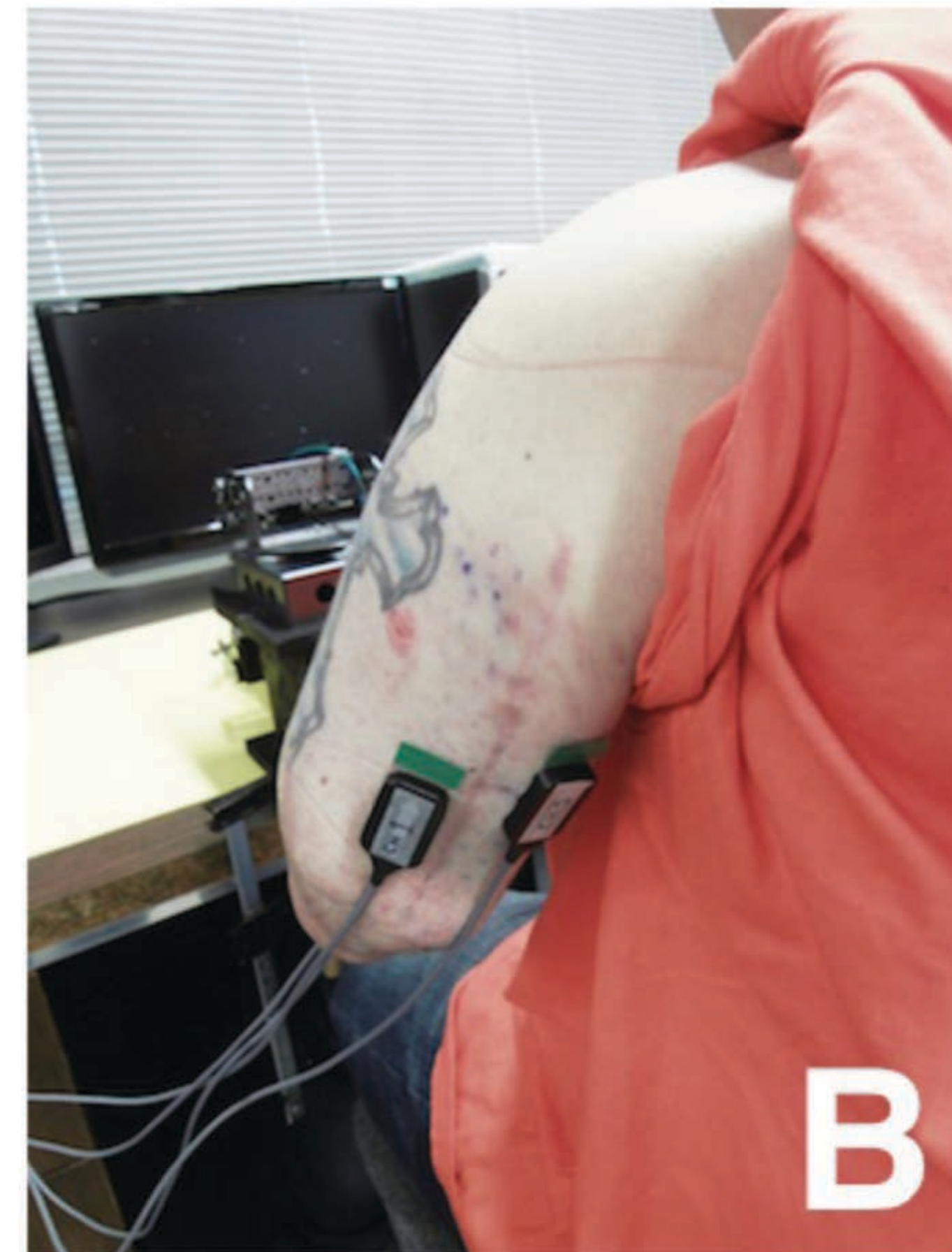
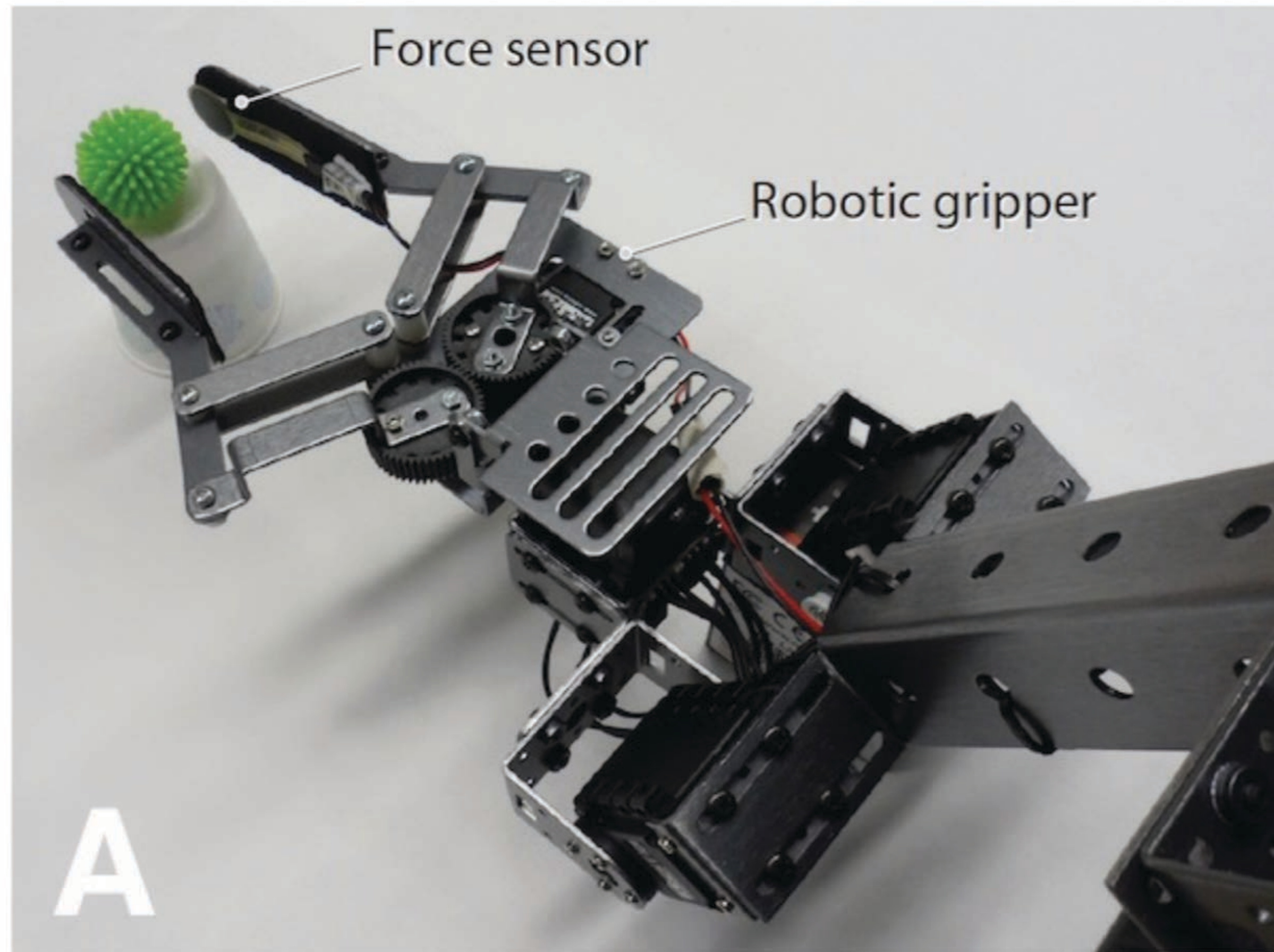

P.M. Pilarski, M.R. Dawson, T. Degris, J.P. Carey, K.M. Chan, J.S. Hebert, and R.S. Sutton, "Adaptive Artificial Limbs: A Real-time Approach to Prediction and Anticipation," *IEEE Robotics & Automation Magazine*, Vol. 20(1): 53–64, March 2013.

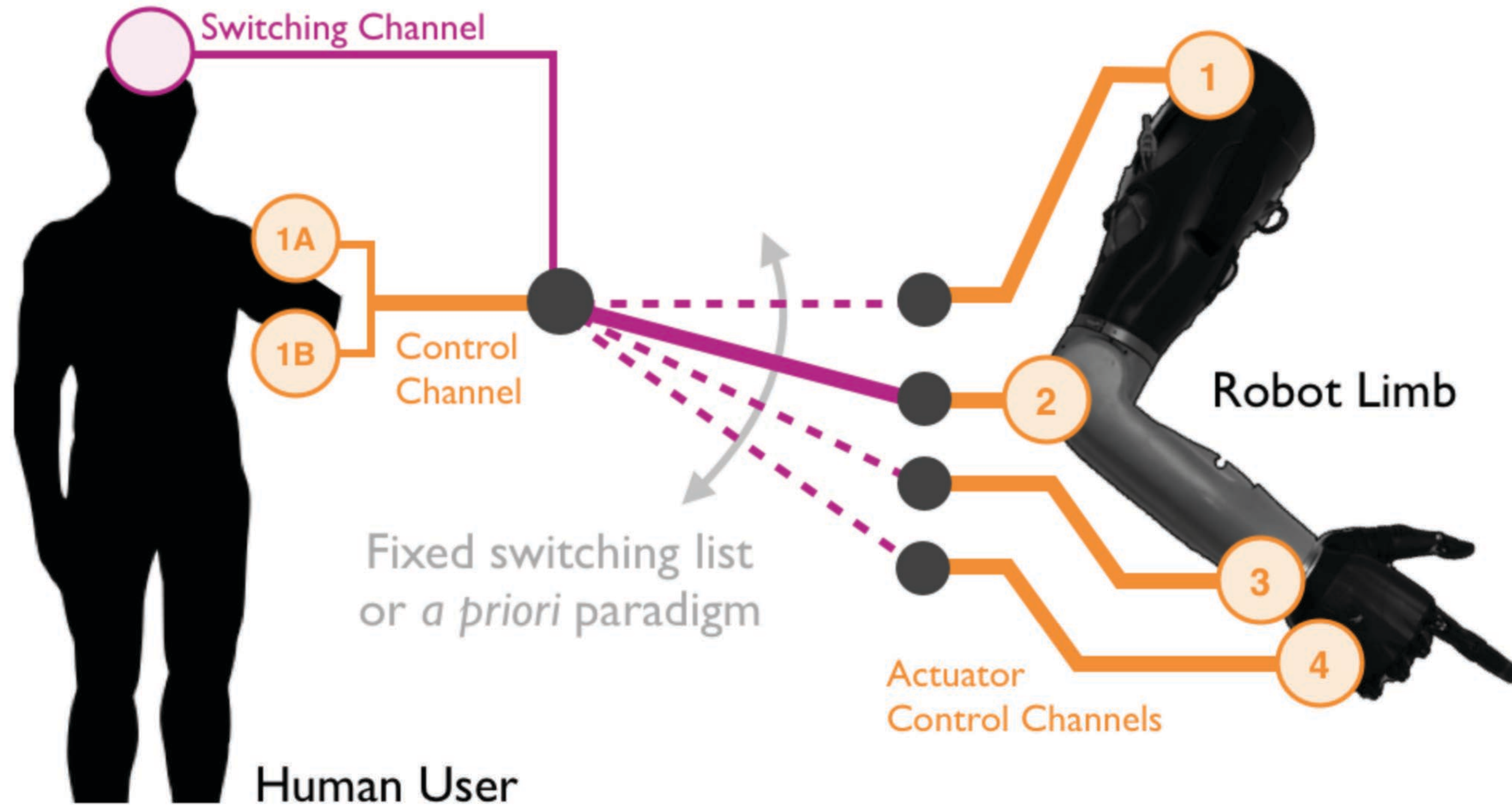

A. L. Edwards, "Adaptive and Autonomous Switching: Shared Control of Powered Prosthetic Arms Using Reinforcement Learning," MScRS Thesis, Faculty of Rehabilitation Medicine, University of Alberta, 2016.

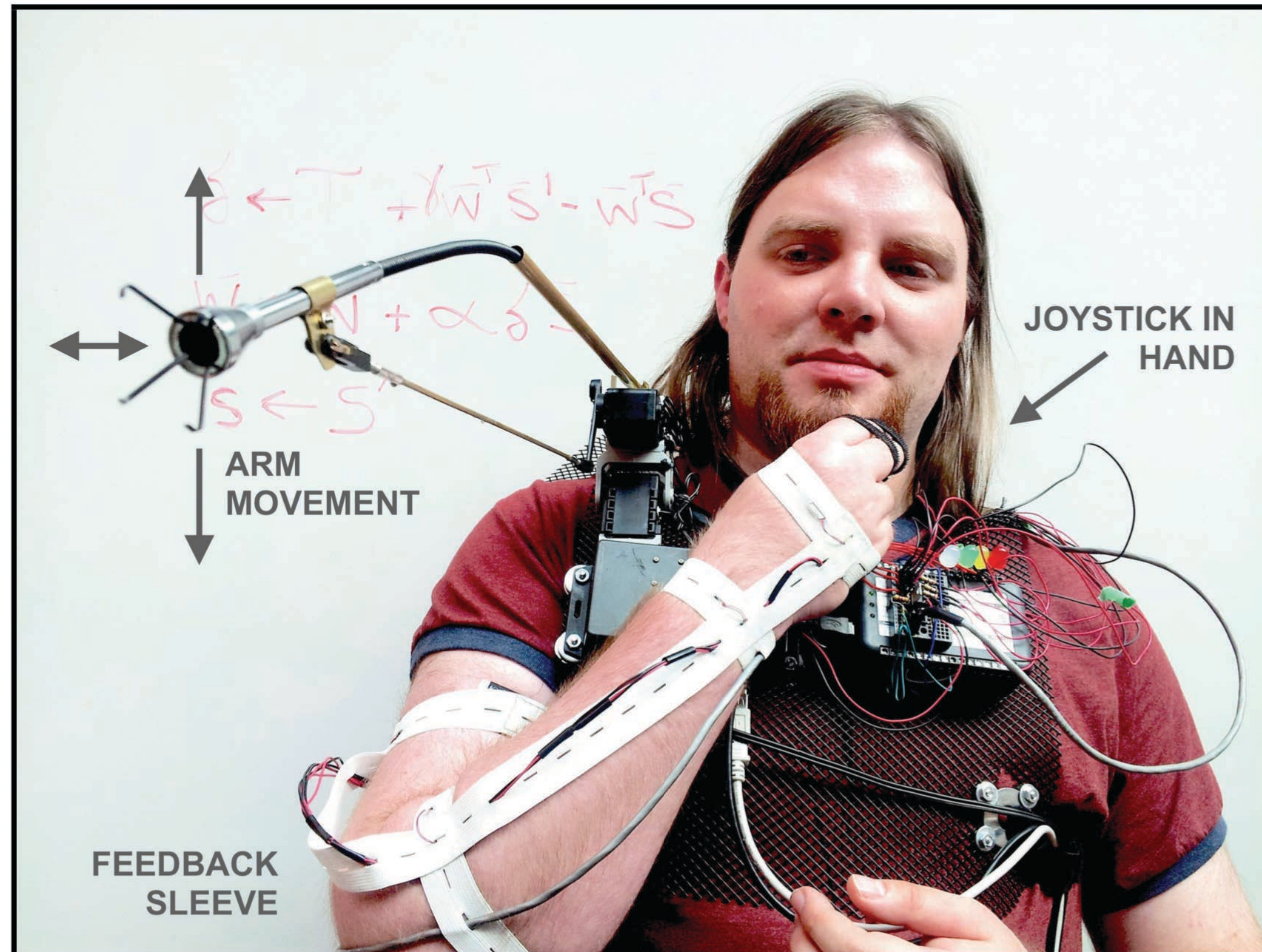

A. S. R. Parker, A. L. Edwards, P. M. Pilarski, "Exploring the Impact of Machine-Learned Predictions on Feedback from an Artificial Limb," *2019 IEEE-RAS-EMBS International Conference on Rehabilitation Robotics (ICORR)*, 24-28 June, 2019, Toronto, 8 pages.

**We have both the technology and
model systems to study human-
machine coordination as joint action.**

C. Castellini et al., “Proceedings of the First Workshop on Peripheral Machine Interfaces: going beyond traditional surface electromyography,” *Frontiers in Neurobotics*, vol. 8, no. 22, Aug. 2014.

Finally!

We have both the technology and model systems to study human-machine coordination as joint action.

Real-time
Machine Learning

We have ~~both the technology~~ and
model systems to study human-
machine coordination as joint action.

GVEs

We have ~~both the technology~~ and
model systems to study human-
machine coordination as joint action.



File photo by *The Canadian Press*/Amber Bracken, 2019

Fixed Wrist (2x speed)

GaMA

Lavoie et al., *JOV*, 2018

Valevicius et al.,

Gait & Posture, 2019

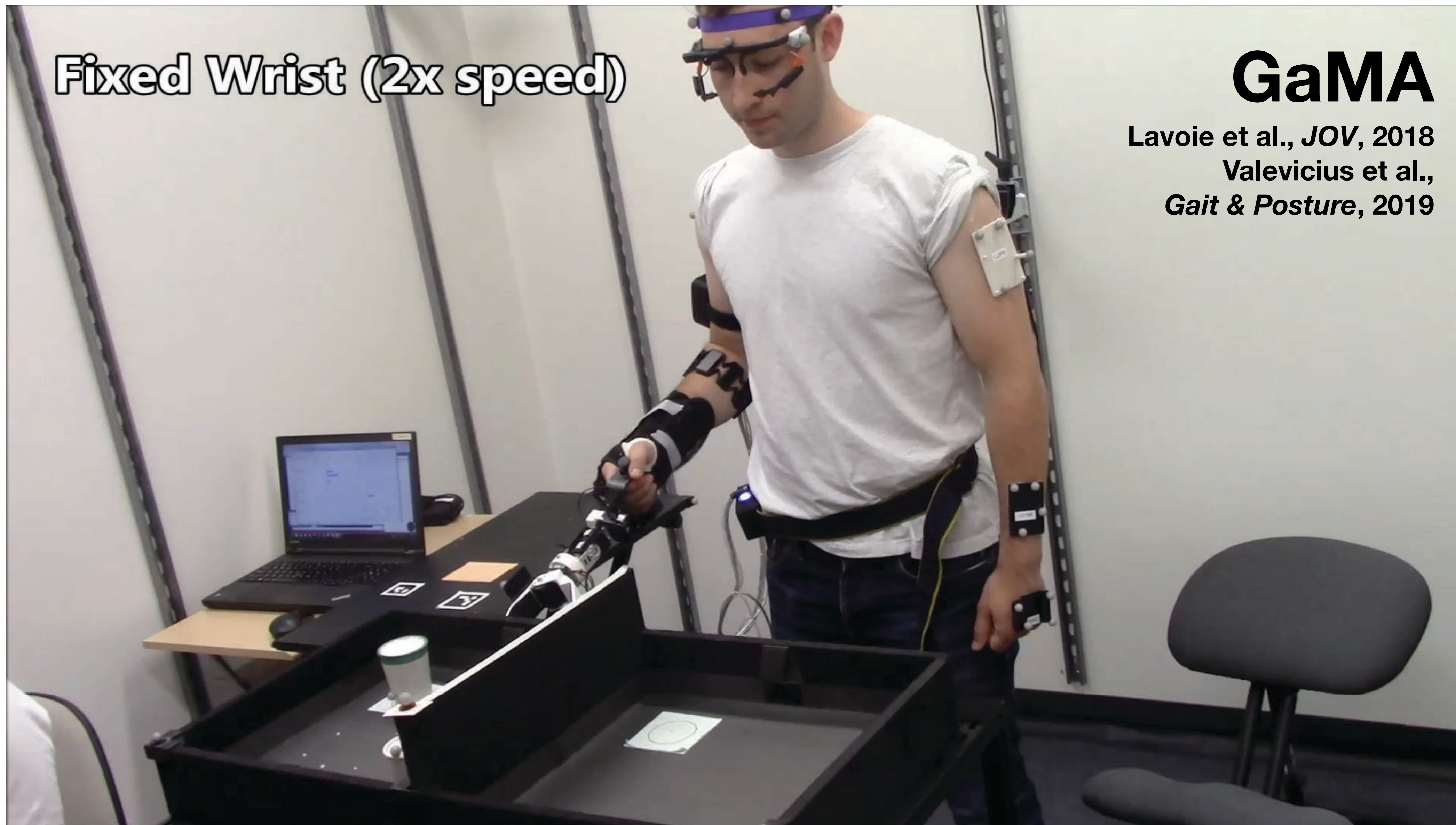

Brenneis et al., "The Effect of an Automatically Levelling Wrist Control System," *2019 IEEE-RAS-EMBS International Conference on Rehabilitation Robotics (ICORR)*, 24-28 June, 2019, Toronto, Canada, 8 pages

Both humans and machines
can now represent **goals**, **make**
and **maintain** predictions...

**... can we gain utility by viewing
human-prosthesis action as
joint action?**

... can we gain utility by viewing
human-prosthesis action as
joint action?

(Let's find out!)

hello@amii.ca
www.amii.ca



With thanks to many collaborators:

Dr. Richard Sutton
Dr. Jacqueline Hebert
Dr. Craig Chapman
Dr. Albert Vette
Michael Rory Dawson
Trainees past and present
Dept. CS and Dept. Medicine
Glenrose Rehabilitation Hospital
BLINC Lab, RLAI Lab, ACE Lab



Amii is proudly supported by:



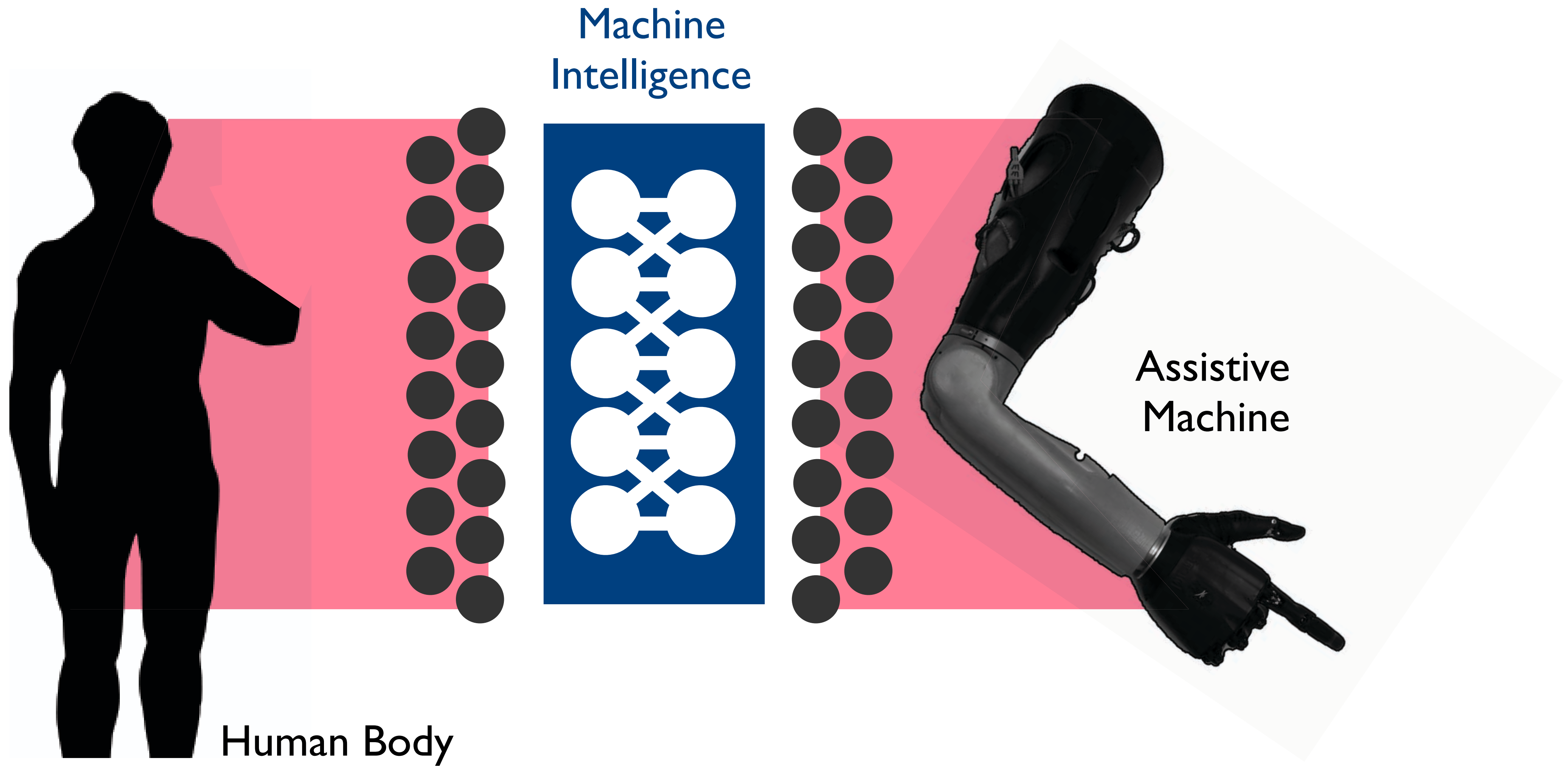



Direct brain-computer interfaces: study participant Jan Scheuermann feeding herself with a robotic limb (University of Pittsburgh); <http://www.upmc.com/media/media-kit/bci/Pages/default.aspx>

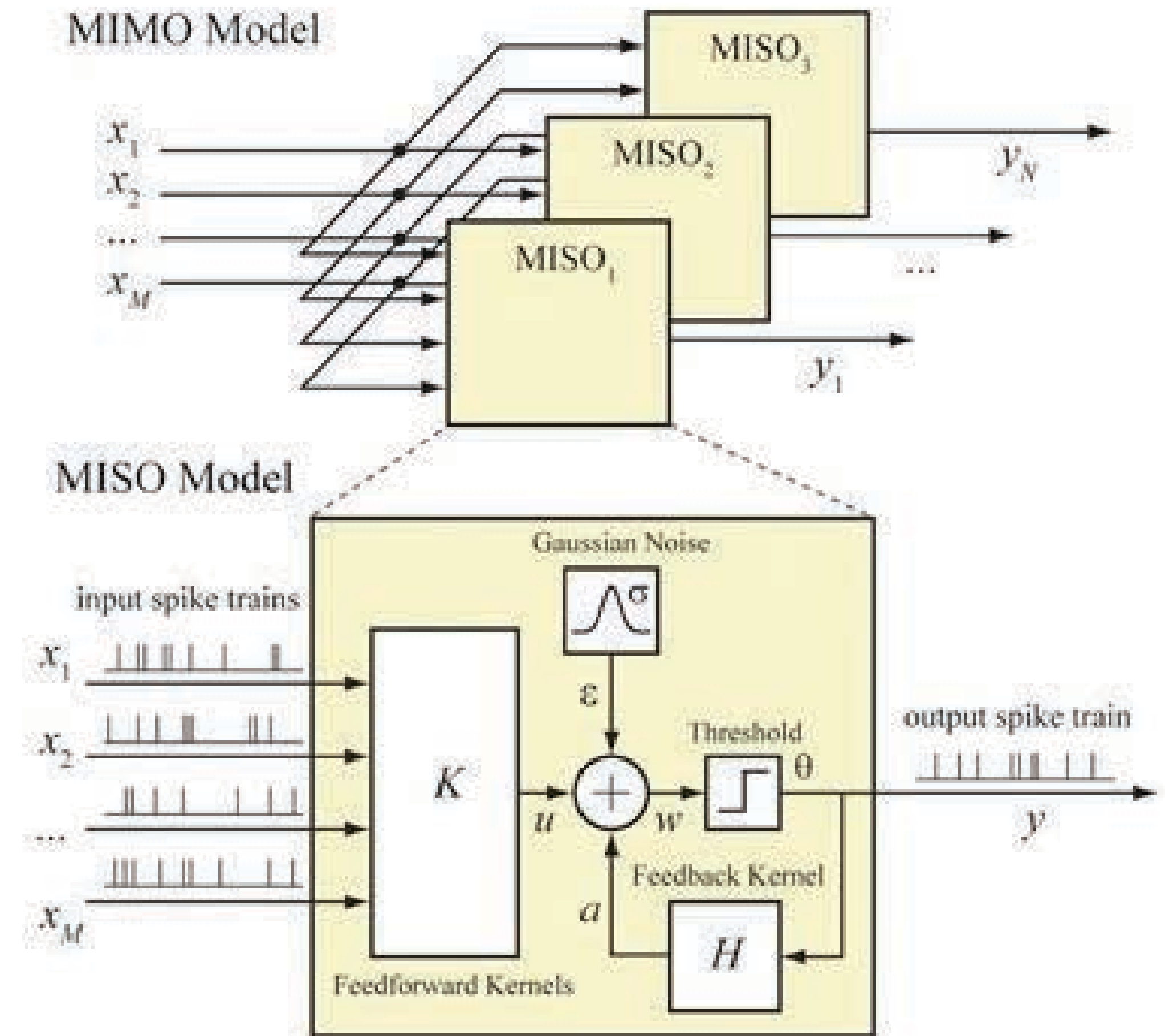
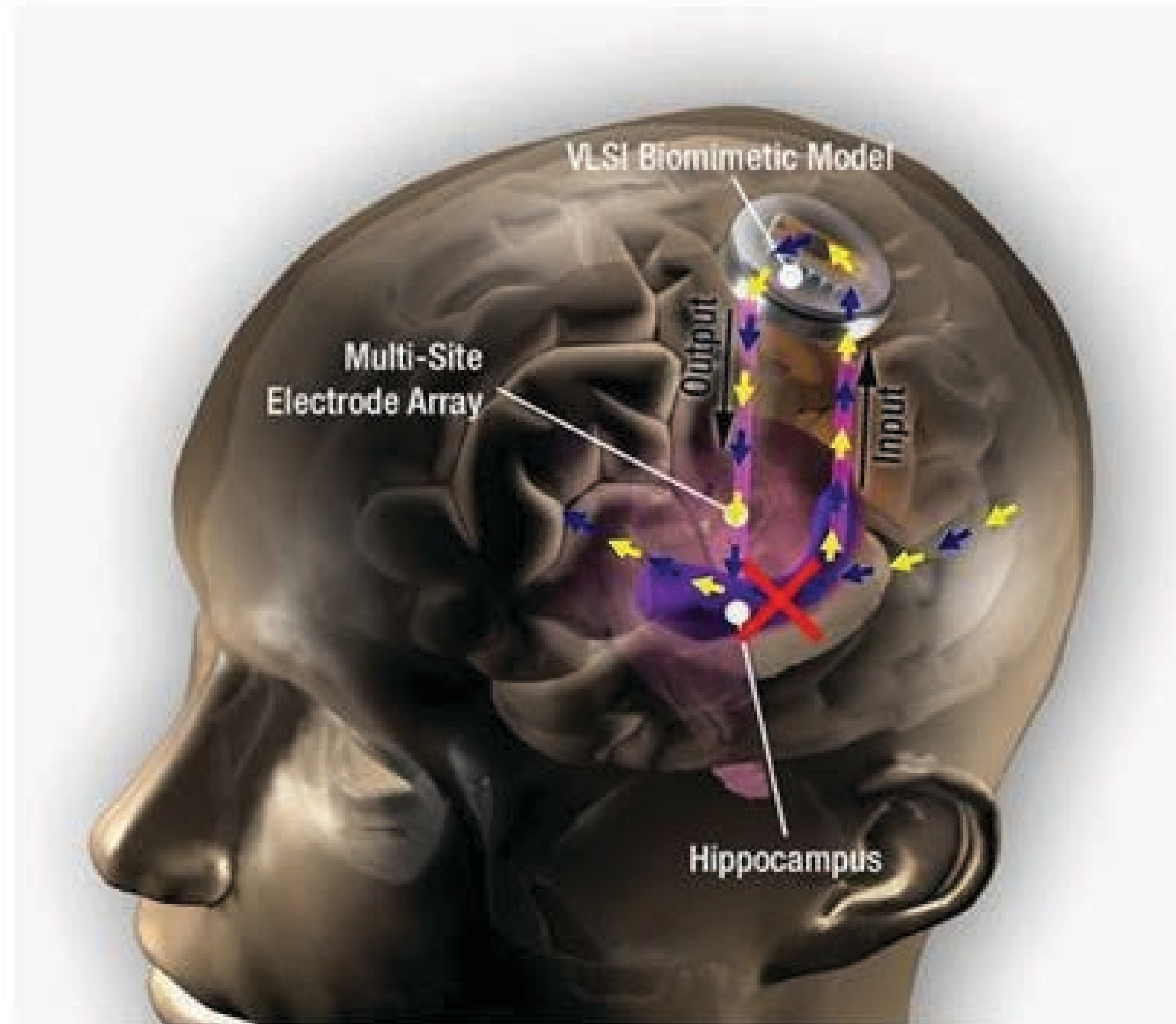

Direct brain-computer interfaces: *memory prostheses* from the Center for Neural Engineering, Viterbi School of Engineering. <https://cne.usc.edu/neural-prosthesis-for-hippocampal-memory-function/> and [IEEE Trans Neural Syst Rehabil Eng.](#) 2018, 26(2):272-280.

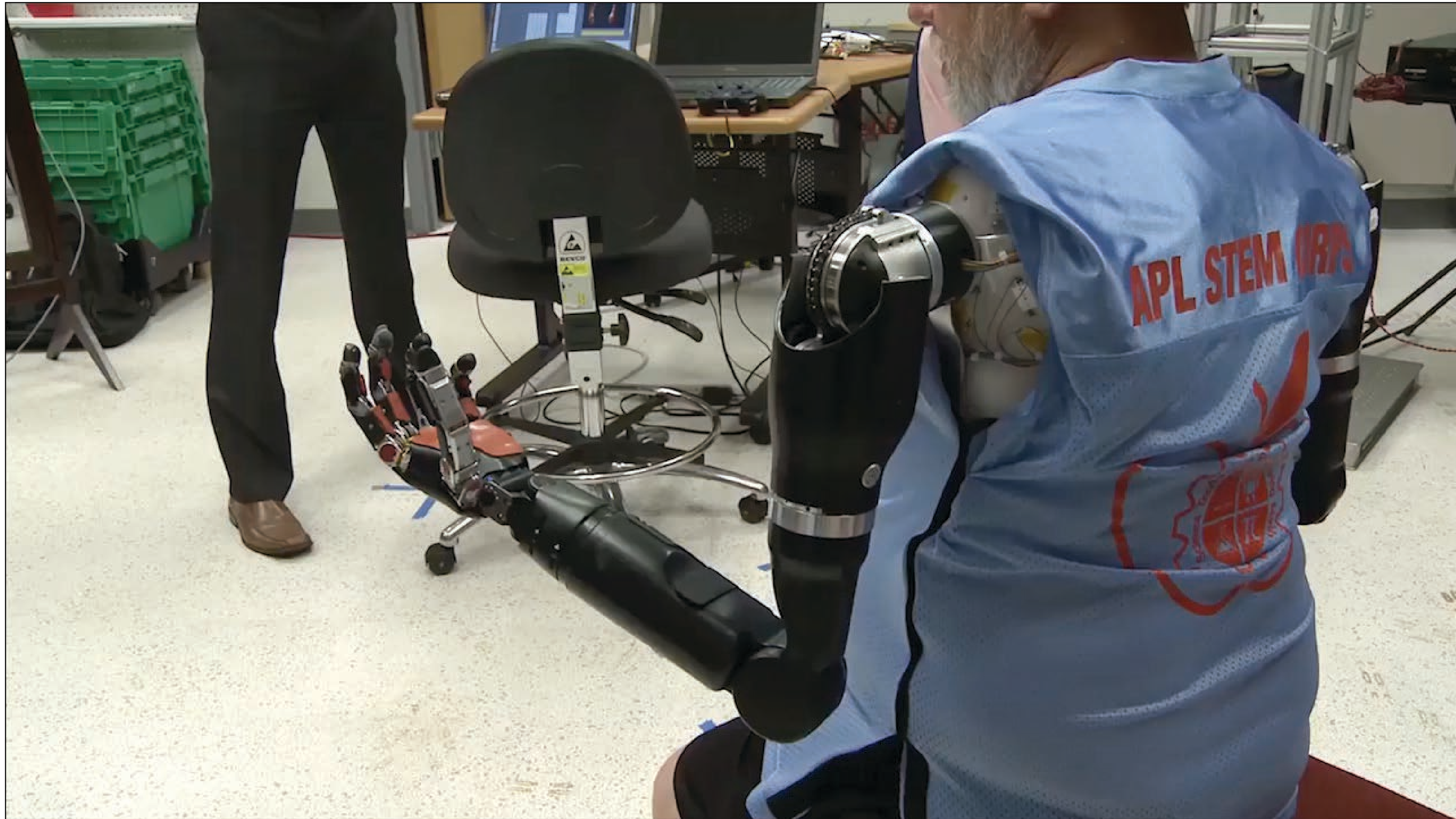

Brain-body-machine interfaces: “Amputee Makes History with APL’s Modular Prosthetic Limb” (JHU Applied Physics Laboratory); <https://youtu.be/9NOncx2jU0Q>



Brain-body-machine interfaces: “APL’s Modular Prosthetic Limb Reaches New Levels of Operability” (JHU Applied Physics Laboratory); <https://youtu.be/-0srXvOQlu0>

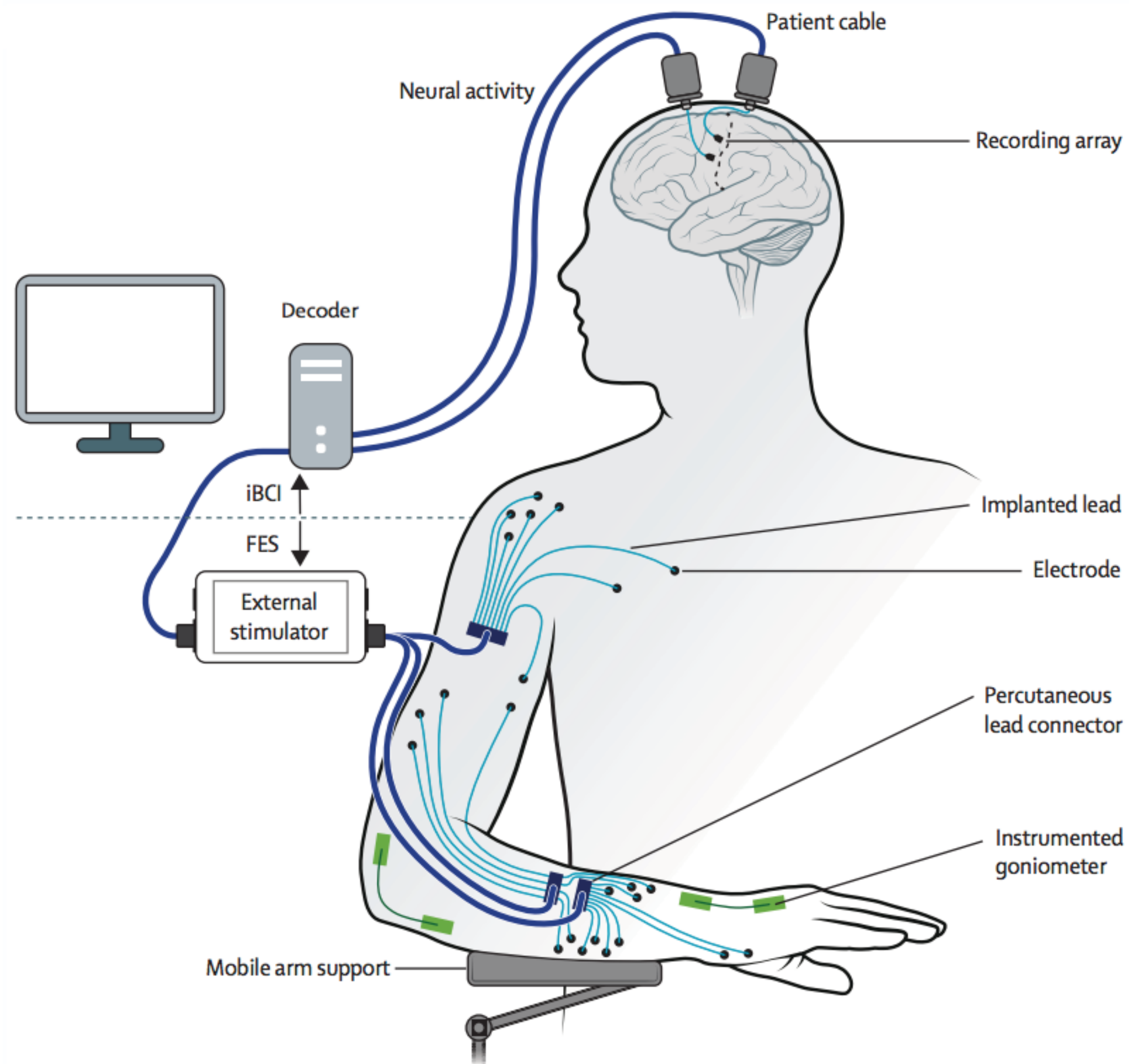

Brain-body-machine interfaces: “Restoration of reaching and grasping movements through brain-controlled muscle stimulation in a person with tetraplegia: a proof-of-concept demonstration” Ajiboye, A Bolu et al., *The Lancet*, Volume 389 , Issue 10081, 1821-1830, 2017.

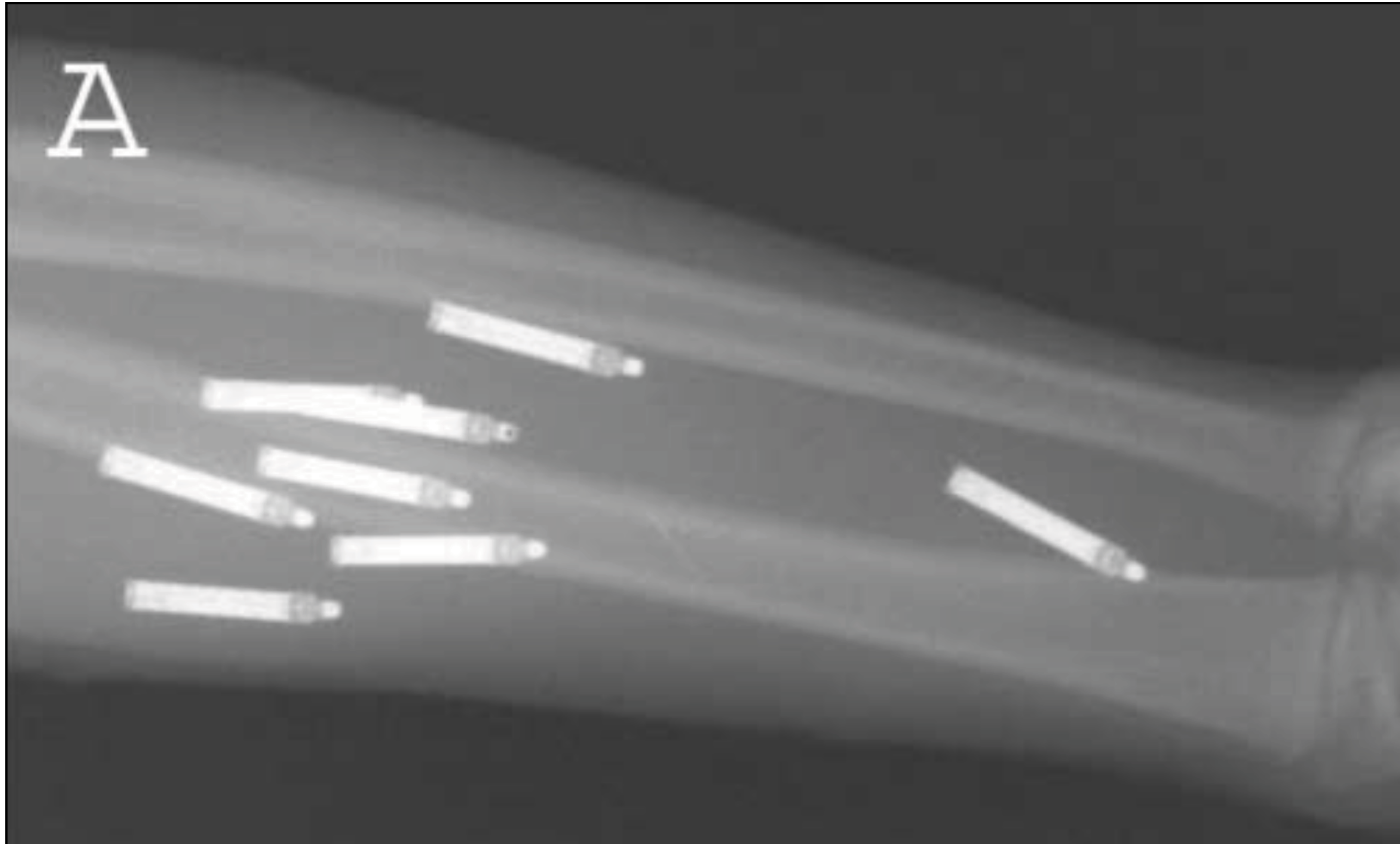

Brain-body-machine interfaces: Baker et al., “Continuous Detection and Decoding of Dexterous Finger Flexions With Implantable MyoElectric Sensors,” *IEEE TNSRE* 18(4):424-32, 2010.



Brain-body-machine interfaces: “Brain-Machine Interface @ EPFL- Wheelchair” (École polytechnique fédérale de Lausanne); <https://youtu.be/0-1sdtnuqcE>



University of Alberta: <http://blinlab.ca>

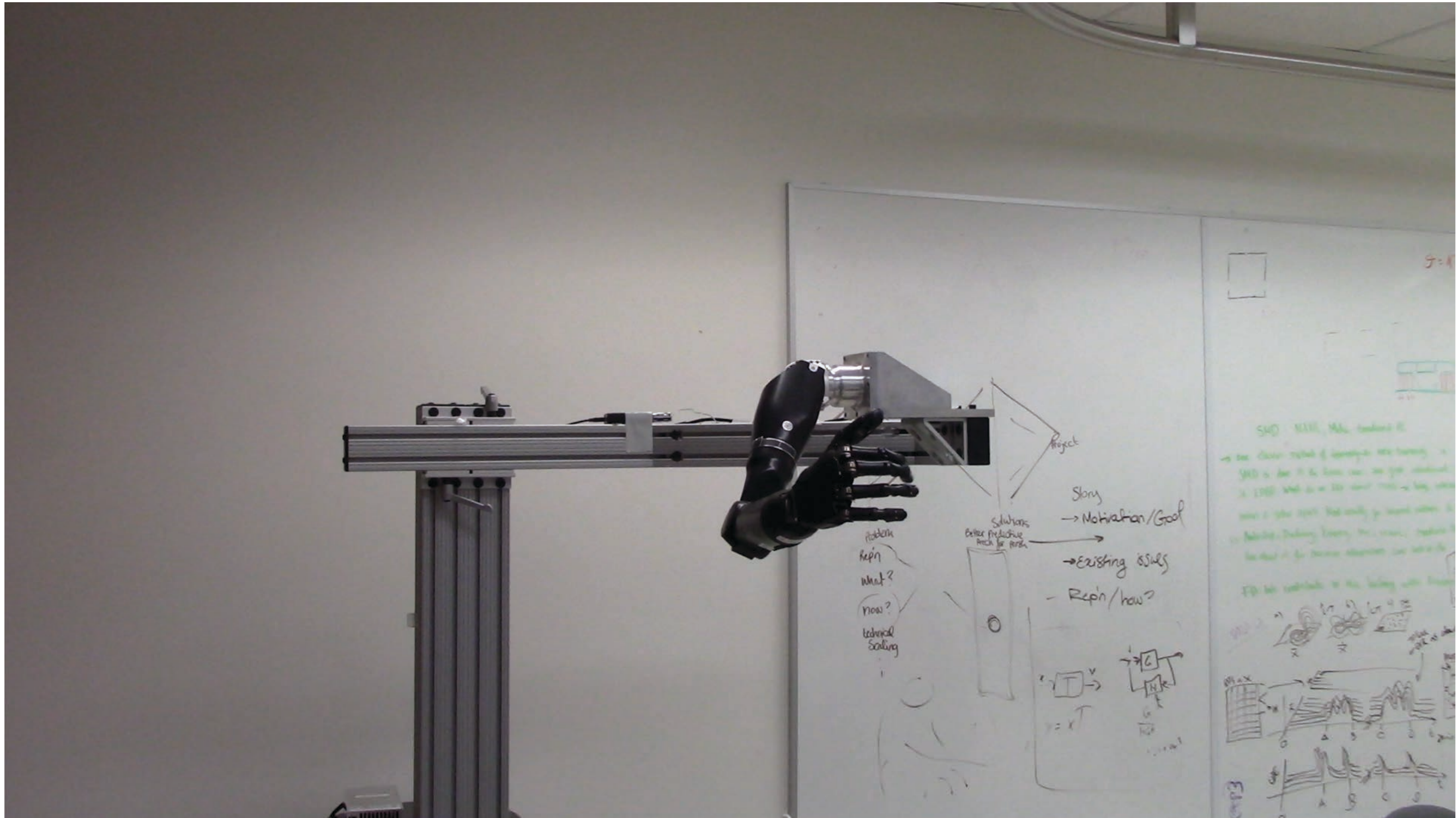

University of Alberta: <http://blinlab.ca>, <https://www.smartnetworkcentre.ca/>

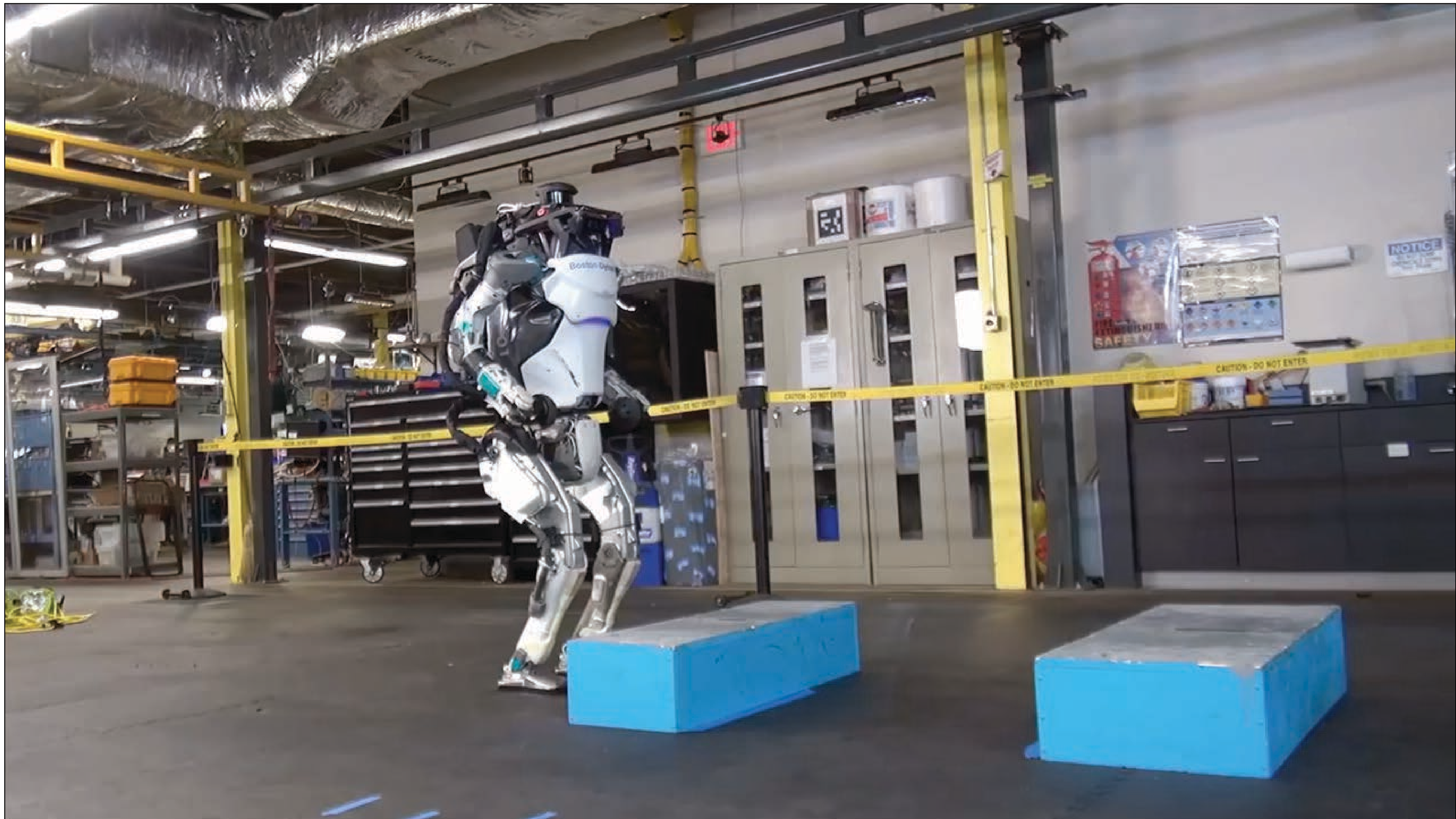

And in case you were wondering what the robots are up to these days...

Atlas Robot (Boston Dynamics): <https://youtu.be/fRj34o4hN4I>



Exoskeletons: UC Berkeley spin-off suitX exoskeleton technology;
<https://www.youtube.com/watch?v=I3roYI3CB2Y>